

Архангельск (8182)63-90-72
Астана (7172)727-132
Астрахань (8512)99-46-04
Барнаул (3852)73-04-60
Белгород (4722)40-23-64
Брянск (4832)59-03-52
Владивосток (423)249-28-31
Волгоград (844)278-03-48
Вологда (8172)26-41-59
Воронеж (473)204-51-73
Екатеринбург (343)384-55-89
Иваново (4932)77-34-06

Ижевск (3412)26-03-58
Иркутск (395)279-98-46
Казань (843)206-01-48
Калининград (4012)72-03-81
Калуга (4842)92-23-67
Кемерово (3842)65-04-62
Киров (8332)68-02-04
Краснодар (861)203-40-90
Красноярск (391)204-63-61
Курск (4712)77-13-04
Липецк (4742)52-20-81
Киргизия (996)312-96-26-47

Магнитогорск (3519)55-03-13
Москва (495)268-04-70
Мурманск (8152)59-64-93
Набережные Челны (8552)20-53-41
Нижний Новгород (831)429-08-12
Новокузнецк (3843)20-46-81
Новосибирск (383)227-86-73
Омск (3812)21-46-40
Орел (4862)44-53-42
Оренбург (3532)37-68-04
Пенза (8412)22-31-16
Казахстан (772)734-952-31

Пермь (342)205-81-47
Ростов-на-Дону (863)308-18-15
Рязань (4912)46-61-64
Самара (846)206-03-16
Санкт-Петербург (812)309-46-40
Саратов (845)249-38-78
Севастополь (8692)22-31-93
Симферополь (3652)67-13-56
Смоленск (4812)29-41-54
Сочи (862)225-72-31
Ставрополь (8652)20-65-13
Таджикистан (992)427-82-92-69

Сургут (3462)77-98-35
Тверь (4822)63-31-35
Томск (3822)98-41-53
Тула (4872)74-02-29
Тюмень (3452)66-21-18
Ульяновск (8422)24-23-59
Уфа (347)229-48-12
Хабаровск (4212)92-98-04
Челябинск (351)202-03-61
Череповец (8202)49-02-64
Ярославль (4852)69-52-93

<https://banner.nt-rt.ru/> || brr@nt-rt.ru

Electronic Industry Solutions







Table of Contents

Applications 7

Lithium Ion Battery Production..... 7

Solar Panel Production..... 13

IC Chips and Printed Circuit Boards17

Mobile Device Production.....23

Contract Manufacturing (EMS)27

Displays (COD)32

Products35

Industry 4.0

Industry 4.0, IoT, and IIoT

The technologies of **Industry 4.0** make data readily available and automate the communication between industrial automation equipment and systems. This enables predictive analysis for machines as well as process optimization across the factory floor.

The **Internet of Things (IoT)** describes the technologies that connect objects—from consumer electronics to industrial components—to the internet.

The **Industrial Internet of Things** (or IIoT) refers specifically to the impact of this innovation on industrial applications.

The key benefits include:

- Visibility and Remote Access to the operational status of machine components (both historically and in real-time)
- Predictive Analytics for more accurate planning of machine maintenance
- Interconnectivity for seamless communication among machines, components, and people



What Does IIoT Mean For Factories?

Visibility and Remote Access Increase Efficiency

In order to ensure efficient processes throughout the factory, machine operators must quickly and easily determine the status of machines. The greater the visibility, the easier it is to identify and resolve problems and keep operations running smoothly.

Traditional tower lights provide visibility wherever they can be physically seen. However, tower lights equipped with wireless communication capabilities both display a visual indication of an event and transmit wireless alerts. This helps ensure that operational problems are identified and addressed immediately, regardless of whether a machine operator is physically present to see the visual indicator.

An additional benefit of wireless indicators is data logging for use in OEE (Overall Equipment Effectiveness) calculations. Not only can operators respond to alerts quickly as they occur, but a history of alerts can also be stored and analyzed offline. This historical data can be used to track machine uptime, production volume, rejected parts, and other key metrics to make more informed decisions over time.

Predictive Maintenance Increases Machine Uptime and Availability

In addition to real-time status monitoring, IIoT technologies can also be used to help avoid machine failures thanks to predictive maintenance.

By monitoring machine components in real-time for increases in vibration and temperature, problems can be detected and resolved before they become too severe and cause additional damage or result in unplanned downtime. Over time, the historical data creates a valuable machine performance log that can be used to make more informed maintenance decisions down the line.

Interconnectivity Streamlines Factory Communications

Wireless technologies also enable seamless interaction among human workers, and can have a significant impact on the efficiency of manual production lines. For example, instead of requiring machine operators to walk over to the manager area for assistance with a technical issue, a wireless system utilizing connected pushbuttons or switches and tower lights can be used to alert managers when assistance is needed on the line.

Is Your Business IIoT-Ready?

From keeping machines running smoothly to enabling seamless communication among machines, components, and people, the benefits of IIoT technologies are tangible. It can be challenging knowing where to start and how to use these technologies to their fullest advantage. Answering the following questions can help manufacturing facilities identify the best technologies to meet their immediate business needs and start taking advantage of the long-term benefits of IIoT.

- What are the inefficiencies in your operations?
- What kind of data would help you overcome these inefficiencies?
- What communication processes need to be in place in order to utilize data in a meaningful way?

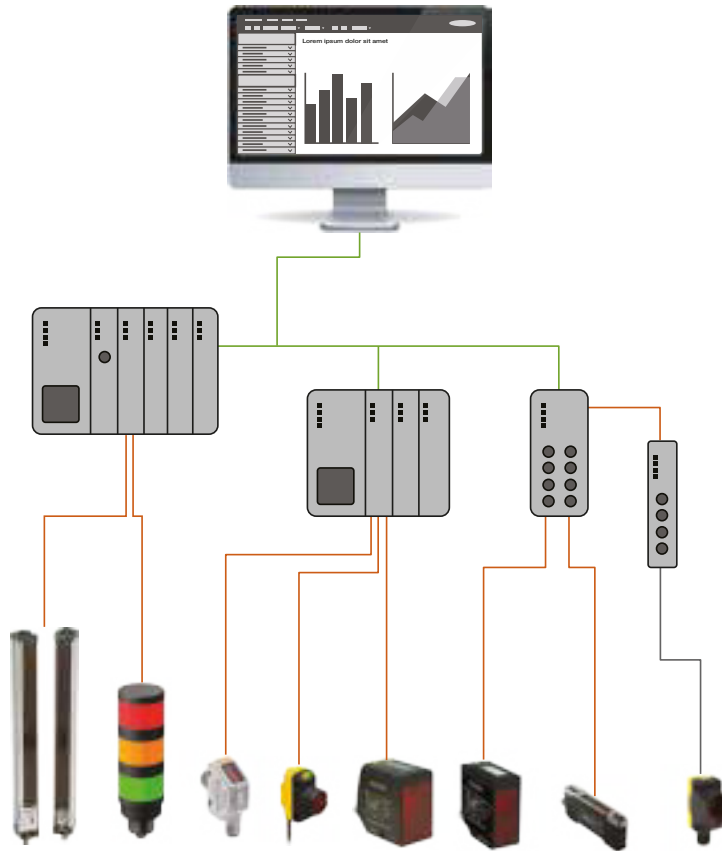

5 Advantages of IO-Link

1. Standardized and Reduced Wiring

IO-Link devices do not require any special or complicated wiring, but can be connected using the same cost-effective standard unshielded 3-wire cables as conventional discrete I/O. In addition, IO-Link also eliminates the need for analog sensors and reduces the variety of cord sets required for sensors, which saves inventory costs. IO-Link also supports a master-slave configuration with passive connection points, which further reduces wiring requirements.

2. Increased Data Availability

Access to sensor-level data helps ensure the smooth operation of system components, streamlines device replacement, and enables optimized machine maintenance schedules—all of which save costs and reduce the risk of machine downtime.

This wealth of valuable data made available through IO-Link is integral for the Industrial Internet of Things (IIoT) and Industry 4.0 initiatives.

3. Remote Configuration and Monitoring

With IO-Link, users can read and change device parameters through the control system software, enabling fast configuration and commissioning that saves time and resources. In addition, IO-Link allows operators to dynamically change the sensor parameters from the control system as needed—such as in the case of product changeover—which reduces downtime and allows machines to accommodate greater product diversity.

In addition, the ability to monitor sensor outputs, receive real-time status alerts, and adjust settings from virtually anywhere allows users to identify and resolve problems that arise on the sensor level in a timely manner. This capability reduces costly downtime and improves overall efficiencies.

4. Simple Device Replacement

In addition to the ability to remotely adjust sensor settings, IO-Link's data storage capability also allows for automated parameter reassignment in case of device replacement (also known as Auto-Device Replacement or ADR). Users can import existing sensor parameter values into a replacement sensor for seamless replacement, getting the new device up and running as quickly as possible.

5. Extended Diagnostics

IO-Link provides users with visibility into errors and health status from each device. This means that users can see not only what the sensor is doing but also how well it is performing—a valuable insight into a machine's efficiency. In addition, extended diagnostics allow users to easily identify when a sensor is malfunctioning and diagnose the problem without shutting down the line or machine.

The combination of real-time and historic data not only reduces troubleshooting efforts as issues arise but also allows for optimization of machine maintenance schedules, saving costs and increasing efficiency in the long term.



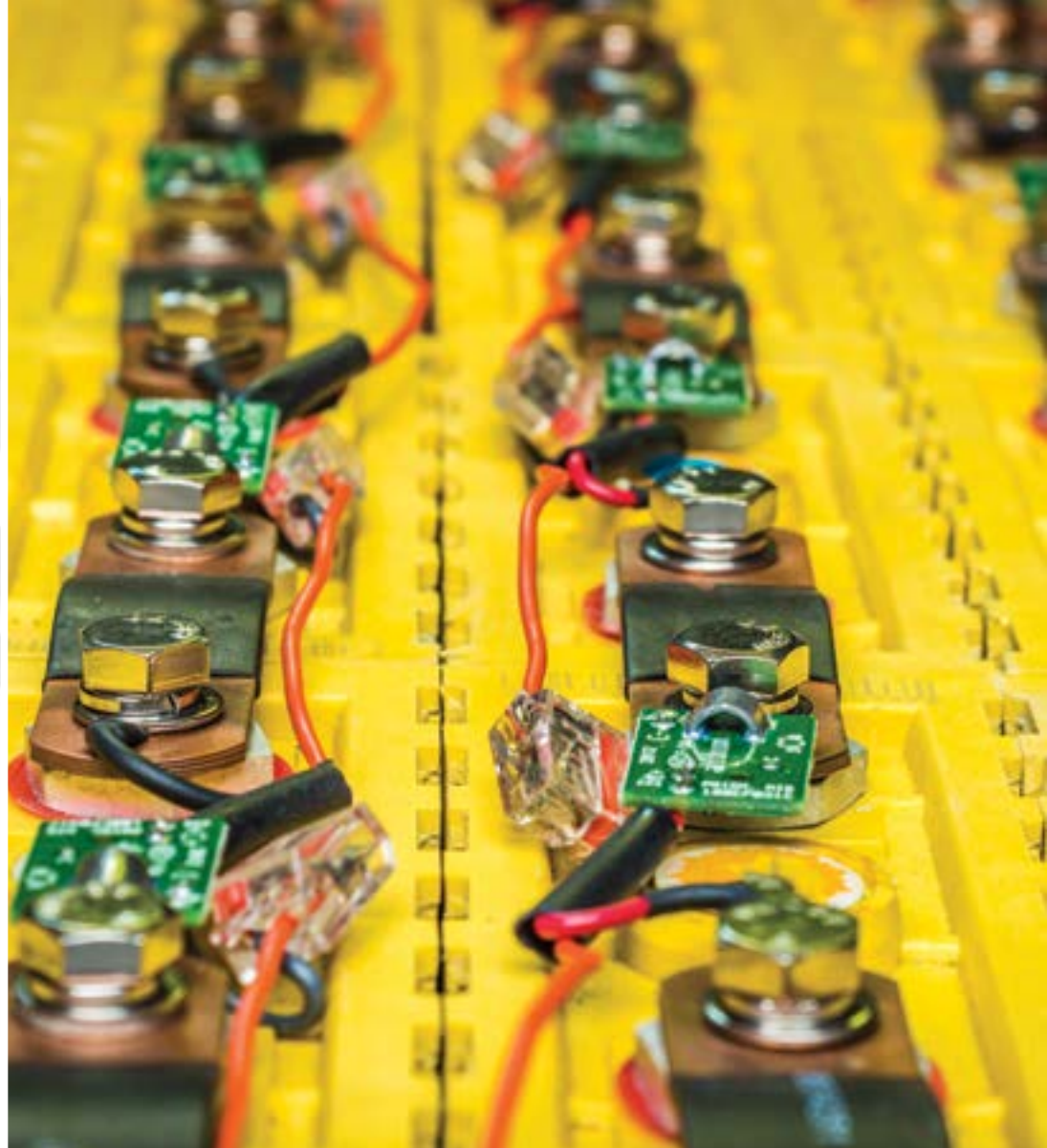

Lithium Ion Battery Production

From precise edge guiding and roll diameter monitoring to glue and tape detection, lithium ion battery production processes require a variety of presence detection, measurement, and inspection solutions to ensure quality control within tight tolerances. Banner Engineering offers an extensive portfolio of fiber optic sensors, photoelectric and laser measurement sensors, and machine vision products for reliable error-proofing in this industry.

Solutions for Lithium Ion Battery Production



see page 45

Tape Detection

Challenge

- Detect tape used to identify damaged film
- Low optical contrast between tape and film
- High speed processing: 1.5 meters per second
- Hard-to-access deployment area with very limited space

Key Features

- White, green, blue, and infrared LED sensing
- Best-in-class response speeds: up to 10 μ s
- Very small, very flexible fiber optic sensors
- IO-Link models available

Featured Solution

- DF-G2 Series High-Speed Fiber Optic Amplifier and plastic fiber optic sensors



Key Benefits

- Detect low-contrast, multicolored, reflective, and other difficult targets
- Reliable performance in challenging high-speed applications
- Easily fits in tight, confined spaces and can be precisely positioned to perform inspections
- Advanced diagnostics, remote monitoring, teaching, and configuration



see page 42

Roll Diameter Monitoring

Challenge

- Control diameter of lithium ion battery film
- Continuous measurement on high-speed roll
- Hard to detect reflective material
- Machine vibration

Key Features

- Available ranges of 100 mm to 1 m, 200 mm to 2 m, or 300 mm to 3 m
- Provides continuous 0-10 V dc or 4-20 mA analog output
- Detects targets using 114 kHz, 174 kHz, or 224 kHz ultrasonic frequencies
- Built-in temperature compensation

Featured Solution

- T30UX Series Ultrasonic Sensor



Key Benefits

- Reliable monitoring of rolls regardless of size
- Reduced machine downtime and product damaged by incorrect tension control
- Immune to target reflectivity and variations in color
- Provides more reliable measurements to minimize waste left on the roll



see page 44

Edge Guiding

Challenge

- Monitor position of film edge on winding machine
- Minute detection of variation in edge position needed
- High-speed winder: up to 1.5 meters of film per second
- Hard-to-access deployment area with very limited space

Key Features

- Heavy-duty shielded fibers
- Detects 500 μ m variation in edge position
- High-power amplifier with world-class long-range sensing capability
- IO-Link models available

Featured Solution

- DF-G3 Series Long-Range Fiber Optic Amplifier and heavy-duty shielded fiber array



Key Benefits

- Resists kinking, cutting, and snagging as well as chemicals and other environmental hazards
- Detects tiny misalignments, enabling precise adjustments to prevent winding errors and reduce material waste
- Advanced diagnostics, remote monitoring, teaching, and configuration



see page 66

Glue Detection

Challenge

- Verify presence and consistency of adhesive on the outer casing of a battery
- Crowded production area with limited deployment space
- Frequent product changeover

Key Features

- All-in-one solution with camera, controller, lens, and light included in one package
- PC, remote or integrated touchscreen operation
- EtherNet/IP™, Modbus/TCP, PROFINET®, PCCC and Serial RS-232 communication
- Full runtime editing capability

Featured Solution

- iVu Series Image Sensor

Other Solutions

- VE Series Smart Camera



Key Benefits

- Simplifies installation and eliminates the expense of purchasing additional components
- Setup, manage, and monitor inspections on the device or from a convenient location
- Enables seamless integration with existing equipment
- Reduces costly downtime by changing inspection parameters while inspections are in progress

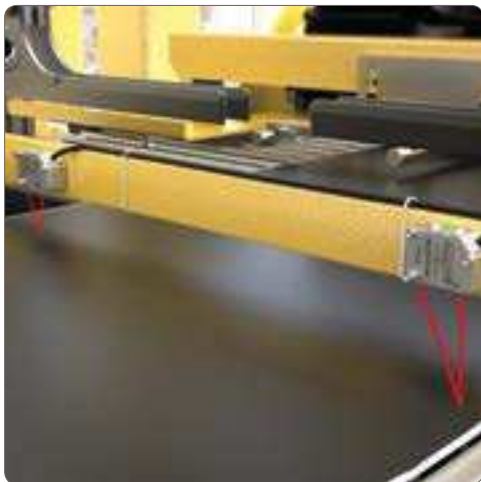

see page 36

Thickness Monitoring

Challenge

- Maintain consistent thickness battery film
- High-speed production process
- Hard-to-access, space-constrained deployment area

Key Features

- 0.002 mm resolution and repeatably
- Fast 0.5 ms response speed and 0.25 ms sampling rate
- Best in class thermal and mechanical stability
- Optional Remote Sensor Display (RSD)

Featured Solution

- LM Series Laser Measurement Sensor



Key Benefits

- Precise measurements for reliable quality and process control
- Reliably solves high-speed applications with fast-moving targets
- Superior thermal stability for more accurate and reliable measurements
- Simplifies setup and monitoring of sensors in difficult-to-access locations



see page 50

Monitoring Safety Doors

Challenge

- Monitor multiple guard doors
- Staff need to frequently access the protected area
- Prevent staff from bypassing safety functions

Key Features

- Achieves Cat 4, PL e, or SIL CL 3 safety ratings alone or in a cascade chain
- Cascade up to 32 switches together in a series
- No contact between switch and actuator
- Unique, high, and low code tamper resistance
- In-Series Diagnostics (ISD)

Featured Solution

- SI-RF Series RFID safety switches

Other Solutions

- SI-MAG Series magnetic safety switches



Key Benefits

- Operates at the highest levels of safety (PL e) without the possibility of fault masking
- Simplifies installation and wiring and frees space on the safety controller
- Allows easy access and minimizes wear and tear
- Ensures that safety functions cannot be bypassed
- Makes it easy to identify and resolve issues, minimizing downtime



see page 44

Presence of Liquid

Challenge

- Detect presence of liquid at a collection site
- Potential exposure to oil and chemicals
- Below ground deployment area
- Provide indication if sensor is non-functional

Key Features

- Small, flexible and chemically resistant fiber optic
- High-performance sensing for low-contrast application
- Intuitive user interface and easy-to-read dual digital display

Featured Solution

DF-G3 Series fiber optic amplifier



Key Benefits

- Reliable detection in challenging environments
- Detects very small amounts of liquid
- Provides output for detection of liquid or damaged fibers
- Simplifies setup, programming, and application monitoring



see page 44

Liquid Detection in a Tube

Challenge

- Detect the presence of liquid in a tube
- Low optical contrast between the tube and liquid
- Multiple inspection points in hard-to-access areas

Key Features

- High-performance sensing in low-contrast application
- Expert TEACH and SET methods
- Cross talk avoidance algorithm
- Easy-to-use mounting straps

Featured Solution

DF-G3LIR Infrared water sensor



Other Solutions

DF-G1 Series general purpose fiber optic amplifier

Key Benefits

- Reliably detects liquids inside translucent or semi-opaque plastic and glass tubing
- Ensures optimal gain and threshold for all applications, including challenging high-speed and low-contrast applications
- Amplifiers can be deployed in close proximity to each other
- Simplifies setup, programming, and application monitoring



see page 68

Liquid Level Detection

Challenge

- Monitor fill levels of tanks to ensure steady supply and prevent overfills
- Hard-to-access equipment
- No wired infrastructure

Key Features

- Combines ultrasonic sensor, wireless node, and battery power supply in one device
- Secure, robust Sure Cross® wireless network
- Immune to variations in target color, reflectivity, and transparency
- Plug-and-play compatibility with Wireless Solutions Kit for tank monitoring

Featured Solution

Q45UA all-in-one ultrasonic sensor and wireless node



Other Solutions

K50U ultrasonic sensor
QT50U with Performance Series -P14 Node

Key Benefits

- Installs easily and can be deployed permanently or redeployed without altering infrastructure
- Eliminates the hassle and expense of running communication cable to connect devices
- Can be used to monitor a wide range of wet or dry materials
- Provides access to real time and historical data and makes it easy to create visualization tools, warnings, and alarms to ensure maximum uptime



Film Slicing Machine

Safety Monitoring

see page 46

Challenge

- Safeguard multiple safety devices
- Complex logic and multiple safety scenarios
- Communicate with HMI to display machine status

Featured Solution

XS26 Series expandable safety controllers with Ethernet



Other Solutions

SC26 Series safety controllers
SC10

Key Features

- Powerful software offering intuitive icon-based, drag-and-drop operation
- Base controller with 26 inputs and two dual-channel safety outputs supports up to eight expansion I/O modules
- Can be configured for virtual non-safety status outputs and virtual non-safety inputs

Key Benefits

- Configure safety program in minutes and test configuration prior to implementation
- Scalable solution can be expanded to fit changing machine requirements
- Two-way communication between the safety controller and PLC, HMI, and other devices for advanced functionality and diagnostic

Access Protection

see page 49

Challenge

- Safeguard access to film slicing area
- Requires redundant, self-checking outputs
- Limited space for deployment

Featured Solution

LP Basic Series compact Type 4 safety light curtain



Other Solutions

LP Series full feature compact Type 4 safety light curtain
SLC4

Key Features

- Low-profile, compact design
- Provides basic functionality auto start/restart (trip output)
- Zone and status indicators plus digital display to indicate number of beams blocked and detailed diagnostics

Key Benefits

- Fits easily into small spaces without interfering with operations or processes
- Cost-effective safety device for simple applications
- Minimizes downtime by making it easy to troubleshoot and quickly resolve issues

Cabinet Illumination

see page 53

Challenge

- Illuminate interior of a machine control panel
- Space-constrained deployment area
- DC powered equipment

Featured Solution

WLS15 Series Low Profile, Low Power LED Strip Light



Key Features

- Bright LED strip light with diffuse window
- Slim, space-saving 15 mm profile
- Flexible mounting options
- Operates on 12 V dc or 24 V dc in one model

Key Benefits

- Provides bright, even illumination with no hot spots
- Installs easily in confined areas without disrupting the work environment or obstructing sightlines
- Integrates easily into existing equipment





Solar Cell Production

Printed circuit board (PCB) manufacturing lines include several types of equipment and conveyors that all can benefit from the broad product offering provided by Banner Engineering. From presence detection in high temperatures to ultra-precise measurements to machine safety, Banner Engineering has solutions to critical challenges for PCB and IC chip production lines.

Solutions for Solar Cell Production



see page 38

Solar Wafer Detection

Challenge

- Detect the presence/absence of a solar wafer
- Low reflectivity from light absorbing material
- Minimize interference with processes

Key Features

- Dual teach mode measures distance and light intensity changes compared to a background reference condition
- Reliable sensing range from 25 up to 610 mm

Featured Solution

Q4X Series Laser Distance Sensor



Key Benefits

- Reliably detects across a variety of target colors, materials, and surfaces
- No reflector required for detection
- Can be installed in a convenient location away from the line



see page 40

Solar Wafer Flipping

Challenge

- Detect the presence/absence of a solar wafer
- Low reflectivity from light absorbing material
- Minimize interference with processes

Key Features

- Universal housing with an 18 mm threaded lens or side mounts
- Wide operating range up to 20 m
- Bright LED operating status indicators visible from 360°
- IO Link models available

Featured Solution

QS18 Series Photoelectric Sensors



Key Benefits

- Quick, easy installation
- Real-time feedback simplifies operation and troubleshooting
- Easy installation, wiring, preventative maintenance, and sensor backup



see page 40

Solar Wafer Counting

Challenge

- Detect the presence/absence of a solar wafer
- Low reflectivity from light absorbing material
- Space constrained deployment area

Key Features

- Ultra-miniature housing (22 x 8 x 12 mm)
- High switching frequency
- Blue LED models reliably detect dark, reflective, and transparent objects
- Electronic push button or remote teach

Featured Solution

VS8 Series miniature sensors



Key Benefits

- Fits easily in very small spaces
- Reliable performance in high-speed applications
- Detects challenging targets without requiring a reflector
- Quick, easy setup enables rapid deployment



see page 39

Solar Wafer Counting

Challenge

- Detect the presence/absence of a solar cell
- Light absorbing solar cell reflects very little light
- Reflective surface of the metallic trace between cells

Key Features

- High-speed detection as fast as 250 us, capturing up to 2,000 events per second
- Reliable sensing range up to 300 mm
- Clear intensity readout from angled three-digit display
- Superior resistance to ambient light interference
- Two-point teach can easily detect the metal trace versus the light absorbing material

Featured Solution

Q3X Series Laser Contrast Sensor



Key Benefits

- Reliable performance in high-speed applications
- Sensor can be deployed off the line to avoid interfering with processes
- Easy-to-see feedback simplifies operation and troubleshooting
- Resists nuisance output trips caused by changing light conditions



see page 70

Pressure Monitoring

Challenge

- Ensure pressure levels remain within recommended range
- Identify system problems before failure can occur
- Monitor large, complex system with multiple hard-to-access inspection points

Key Features

- Combines pressure sensor, wireless node, and battery power supply in one device
- Field-proven Sure Cross® wireless architecture

Featured Solution

Performance Series All-in-One Pressure Sensor and Wireless Node



Key Benefits

- Compact, one-piece design simplifies installation and eliminates the need for ordering multiple components
- Integrates easily in applications where infrastructure makes wired solutions impractical, ineffective, or cost-prohibitive
- Collect data from one or multiple points and monitor system performance from any network-enabled location

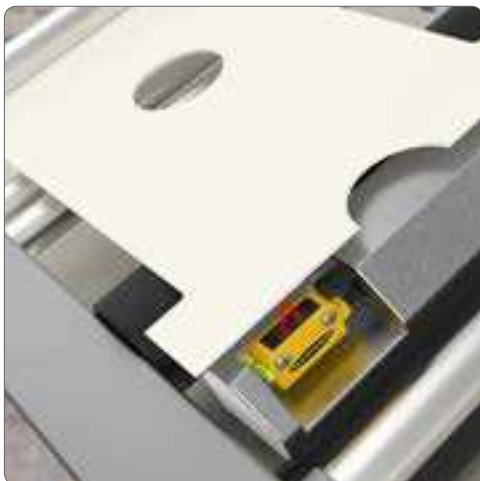

see page 43

Presence Detection on a Buffer Machine

Challenge

- Maintain a steady stream of wafers
- Inconsistencies in color of cell magazines
- Space constrained deployment area

Key Features

- Ultra-miniature housing (22 x 8 x 12 mm)
- Superior resistance to fluorescent light interference
- Rugged design withstands exposure to extreme vibration

Featured Solution

Q12 Series Miniature Sensors

Other Solutions

VS8 Series Miniature Sensors for Precise Detection



Key Benefits

- Fits easily in very small spaces
- Resists nuisance output trips caused by light interference
- Reliable performance in challenging environment
- Long operational life with only routine maintenance

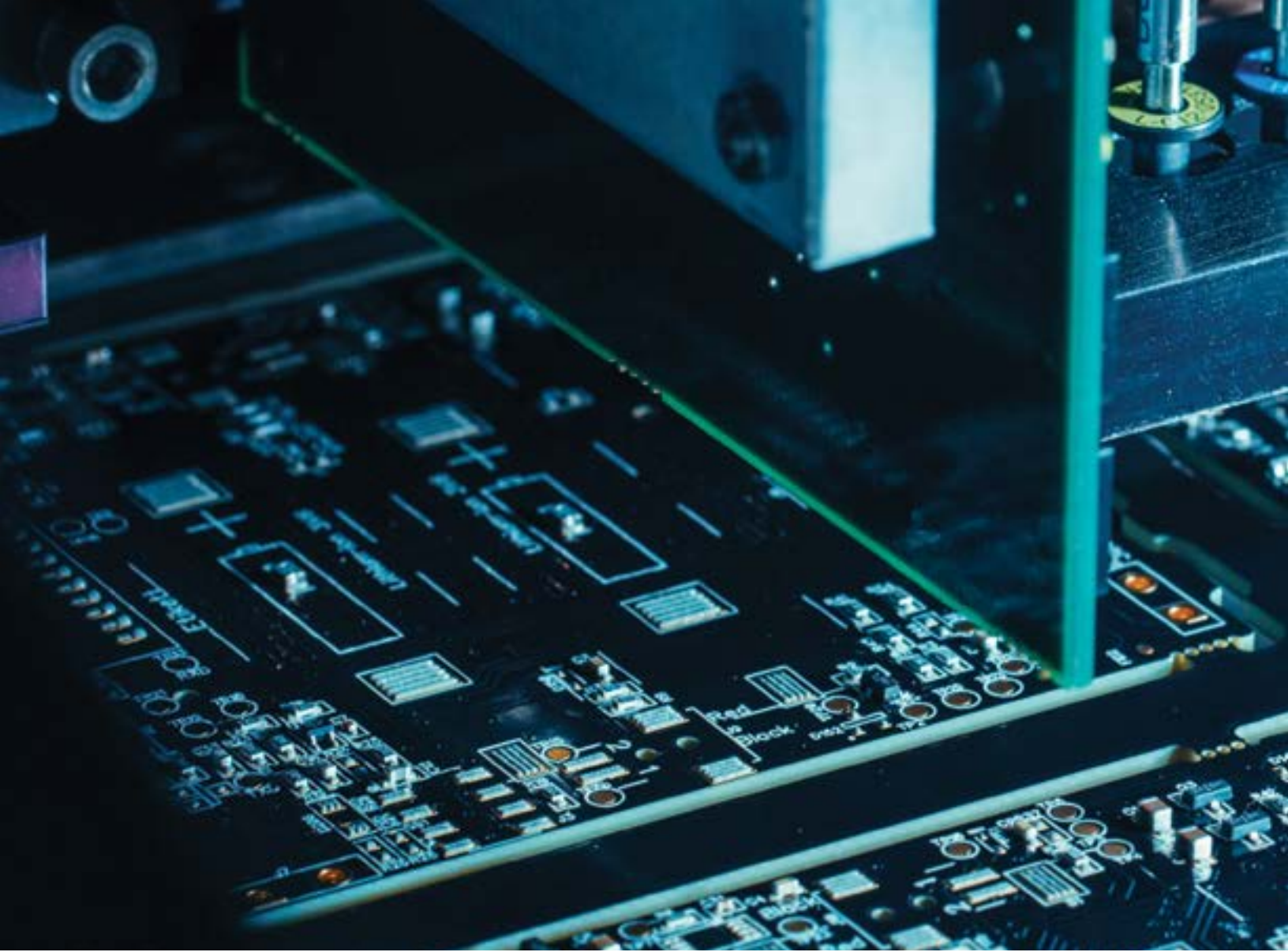

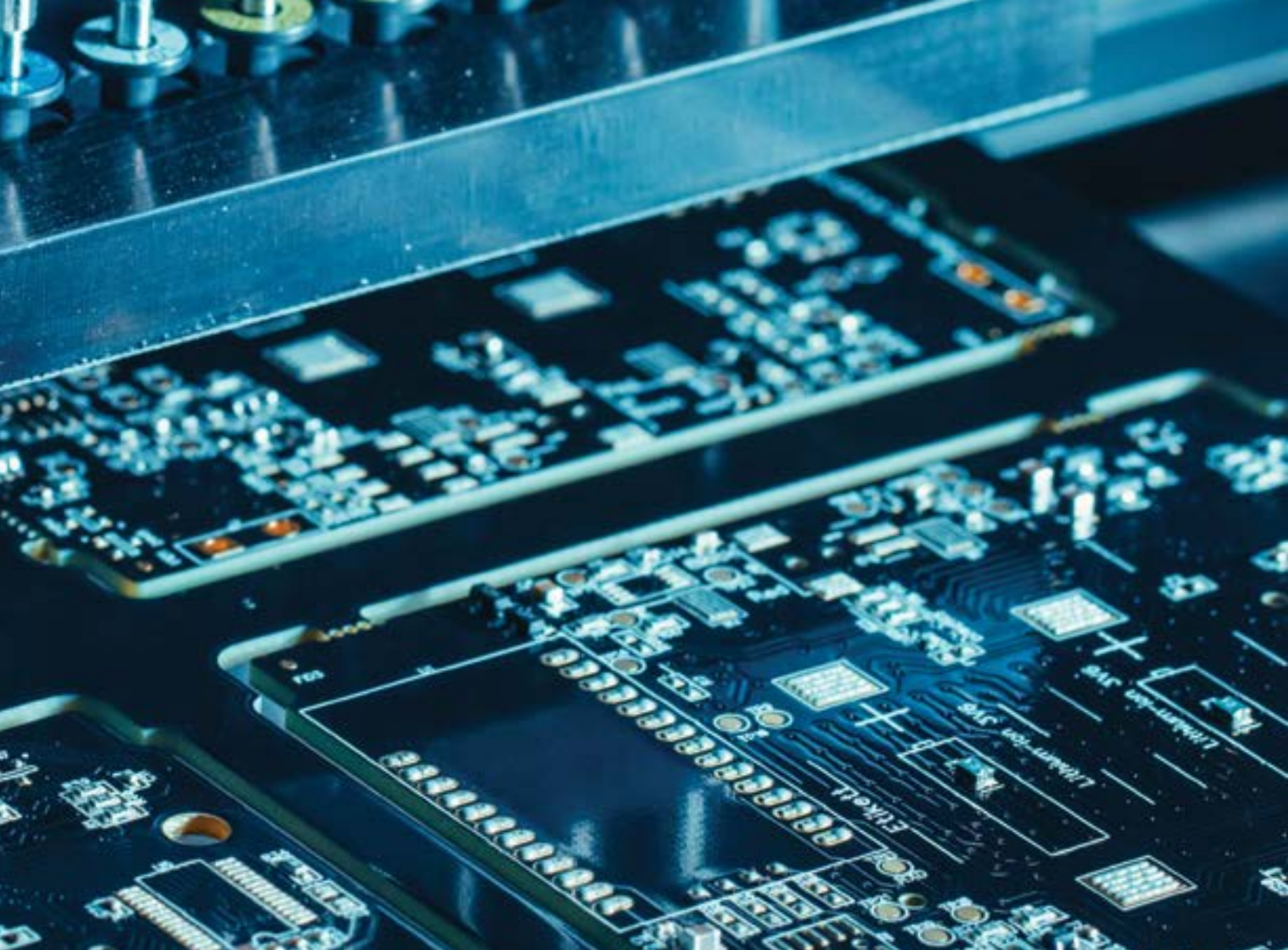

IC Chips and Printed Circuit Boards

Printed circuit board (PCB) manufacturing lines include several types of equipment and conveyors that all can benefit from the broad product offering provided by Banner Engineering. From presence detection in high temperatures to ultra-precise measurements to machine safety, Banner Engineering has solutions to critical challenges for PCB and integrated circuit (IC) chip production lines.

Solutions for Printed Circuit Boards and Integrated Circuit (IC) Chips

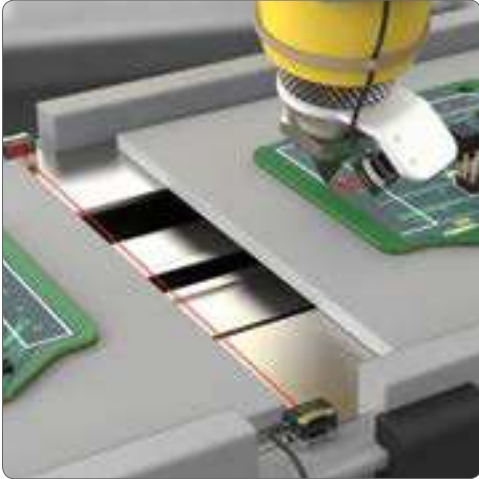

see page 40

Leading Edge And Adhesive Detection

Challenge

- Detect leading edge of printed circuit board (PCB)
- Verify that adhesive has been properly applied to PCB
- Very high levels of precision required for both inspections
- Tight-space constrained deployment area

Key Features

- Space-saving form factor (21.1 x 14.6 x 8 mm)
- Bright, precise spot for precise detection
- High switching frequency

Featured Solution

VS8 Series miniature sensors

Other Solutions

DF-G1 Series fiber optic amplifier with plastic fiber optic sensors



Key Benefits

- Will not interfere with equipment or movement of the PCB on the line
- Precision inspections reduce rework and wasted product
- Minimizes machine downtime for refilling the glue gun
- Reliable performance in high-speed applications

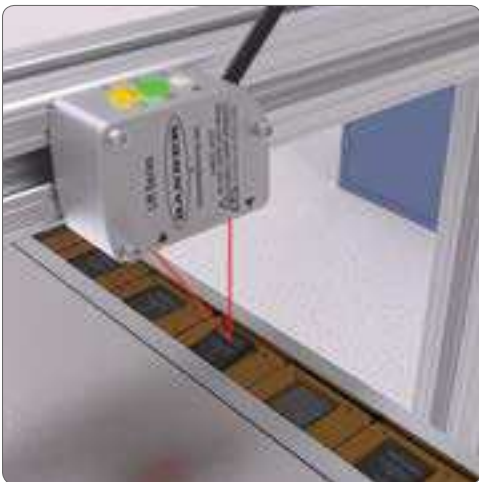

see page 36

Integrated Circuit (IC) Chip Presence

Challenge

- Detect missing, tilted, and multiple IC chips in a nest
- Small, low-profile target
- High-speed inspections

Key Features

- Precise 0.002 mm - 0.004 mm resolution and ± 0.02 - ± 0.07 mm linearity
- Best-in-class thermal and mechanical stability
- Fast 0.5 ms response speed and 0.25 ms sampling rate
- Optional Remote Sensor Display (RSD)

Featured Solution

LM Series precision measurement sensor

Other Solutions

Q4X Series laser distance sensor



Key Benefits

- Ensures parts meet tight tolerances with fewer failures
- Achieves high levels of accuracy in challenging environments
- Reliable performance in high-speed application
- Simplifies setup and monitoring of sensors



see page 45

Leading Edge Detection for Pick-and-Place Machine

Challenge

- Complex, multi-step pick-and-place process
- High level of precision required
- Space-constrained deployment area

Key Features

- Small, precise spot
- Cross talk avoidance algorithm
- Very small, very flexible fiber optic sensors

Featured Solution

DF-G2 Series High Speed Amplifier

Other Solutions

DF-G1 Series General Purpose Amplifier



Key Benefits

- Precise leading edge detection ensures proper placement of SMT components
- Multiple amplifiers can operate in close proximity to each other
- Amplifiers can be installed in a convenient location



see page 66

Integrated Circuit (IC) Chip Orientation

Challenge

- Confirm correct orientation of IC chips on pocket tape
- Space-constrained deployment area
- Frequent product changeover

Key Features

- All-in-one solution with camera, controller, lens, and light included in one compact package
- Setup and manage inspections using Vision Manager PC software, remote touchscreen, or integrated touchscreen
- EtherNet/IP™, Modbus/TCP, PROFINET®, PCCC and Serial RS-232 communication
- Full runtime editing capability

Featured Solution

iVu Series image sensor with integrated touch screen and light



Other Solutions

VE Series Smart camera

Key Benefits

- Simplified installation without the expense of purchasing additional components
- Setup, manage, and monitor inspections on the device or from a convenient location
- Seamless integration with existing equipment and IIoT data collection
- Change inspection parameters while inspections are in progress

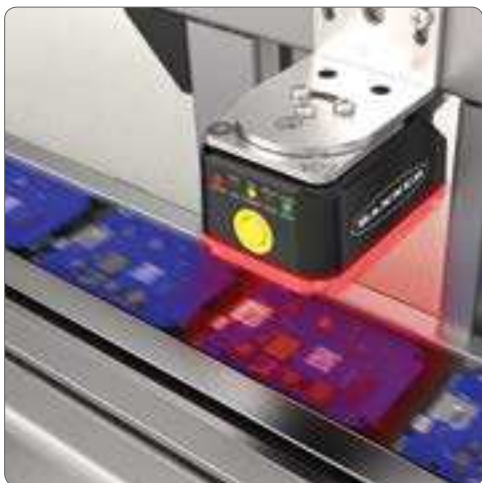

see page 35

Data Matrix Code Reading

Challenge

- Small, complex 2D code on a printed circuit board (PCB)
- Printing errors leading to unreadable codes
- High-speed processes

Key Features

- High-resolution 1.3 MP (1280 x1024 pixels) imager
- Integrated red or multicolor LED lights
- Barcode manager software
- Web interface capability

Featured Solution

ABR Series Imager-Based Barcode Reader



Other Solutions

iVu BCR Series Barcode Reader

Key Benefits

- Detects very fine details on small, complex, and challenging barcodes
- Optimizes the contrast between the Data Matrix code and the PCB
- Intuitive flowchart programming simplifies inspection setup
- Setup, manage, and monitor multiple ABR Series barcode readers from any network-enabled location



see page 67

Clean Room Monitoring

Challenge

- Monitor the status of each clean room
- Signal personnel when it is safe to enter and exit the clean room
- Alert maintenance personnel of alarm conditions via text or email

Key Features

- Indicator provides bright, easy-to-see indication and wireless connectivity
- Controller supports two-way communication with up to 47 wireless nodes
- Controller combines wireless gateway with a logic controller offering advanced capabilities

Featured Solution

DXM700 Wireless Controller and K70 Series Wireless LED Indicators



Key Benefits

- Monitor clean room status from a convenient location
- Activate an indication light and lock/unlock doors from a convenient location
- No additional wiring or alterations to infrastructure required



see page 68

Temperature and Humidity Monitoring at a Chip Shooter

Challenge

- Monitor temperature and humidity levels in multiple locations throughout a facility
- Maintain consistent temperature and humidity levels to suppress electrostatic discharge (ESD)
- Automate the collection of temperature and humidity information
- Minimize downtime during installation

Key Features

- Humidity accuracy of $\pm 2\%$ relative humidity and temperature accuracy of $\pm 0.3\text{ }^{\circ}\text{C}$
- Wireless node is battery powered and preconfigured to work with M12 Series sensor
- Secure, robust Sure Cross[®] wireless network

Featured Solution

Q45 Series Nodes for Predictive Maintenance and M12 Series Temperature and Humidity Sensor



Key Benefits

- Real-time monitoring ensures consistent temperature and humidity levels
- Quick, easy device setup and deployment
- Eliminates the hassle and expense of running communication cable
- Monitors environmental conditions in hard-to-access locations



see page 59

Monitoring Machine Status

Challenge

- Monitoring multiple machines
- View machine status from all angles
- Bright ambient light conditions
- Machines use AC and DC power sources

Key Features

- Features white windows with high intensity LED lights
- AC and DC power options available
- Audible options
- Preassembled models

Featured Solution

TL50 Pro Series Tower Lights

Other Solutions

TL50 Basic Tower Lights
TL50 Core Series Tower Lights
TL70 Series Modular Tower Lights



Key Benefits

- At-a-glance visibility of machine status
- Versatile powering options enable use with a wide range of machines
- No assembly required for rapid deployment



PCB Automated Assembly Station

Monitor Safety Devices see page 47

Challenge

- Monitor multiple safety devices on a small assembly station
- Display machine status on an HMI
- Limited space on the machine control panel

Featured Solution

SC10 Series Compact Safety Controller/Relay Hybrid



Other Solutions

SC26 Series safety controller

Key Features

- Supports a wide range of safety devices
- Intuitive, icon-based programming with drag-and-drop PC configuration
- Two-way industrial Ethernet communication enables 256 virtual non-safe status outputs and 80 virtual non-safe inputs (reset, on/off, cancel off-delay, mute enable)

Key Benefits

- Consolidates the functionality of multiple safety relays into one compact device
- Eliminates the need to buy and stock dedicated relay modules
- Simplifies device setup and management
- Integrates multiple non-safety input and output devices without using additional IO terminals

Safeguard Machine Access Points see page 51

Challenge

- Safeguard point of access on a small assembly station
- Prevent attempts to bypass safety system

Featured Solution

SI-MAG Series Magnetic Safety Switches



Other Solutions

SI-RF Series RFID Safety Switches

Key Features

- Achieves category 4/PLe safety rating with a single sensor
- Two-piece, non-contact safety system
- Coded magnets for tamper resistance
- 3-5 mm tolerance to misalignment

Key Benefits

- Operates at the highest level of safety
- Provides a long operational life, even in applications with persistent use
- Resists attempts to bypass safety functions
- Minimizes machine downtime caused by nuisance trips

Initiate Manual Reset see page 62

Challenge

- Initiate manual reset on assembly station
- Provide status indication
- Unobtrusive operation

Featured Solution

S22 Pro Series Multicolor Touch Button



Other Solutions

K50 Core Series Illuminated Touch Buttons

Key Features

- Multicolor illuminated touch surface
- Ergonomic design requires no physical force to actuate
- Flush mount device with terminal connector options
- Solid state electronics

Key Benefits

- Clear, at-a-glance display of status to quickly resolve issues
- Easy actuation with no hand, wrist, and arm stresses
- Quick, easy installation in panels
- Long operational lifespan



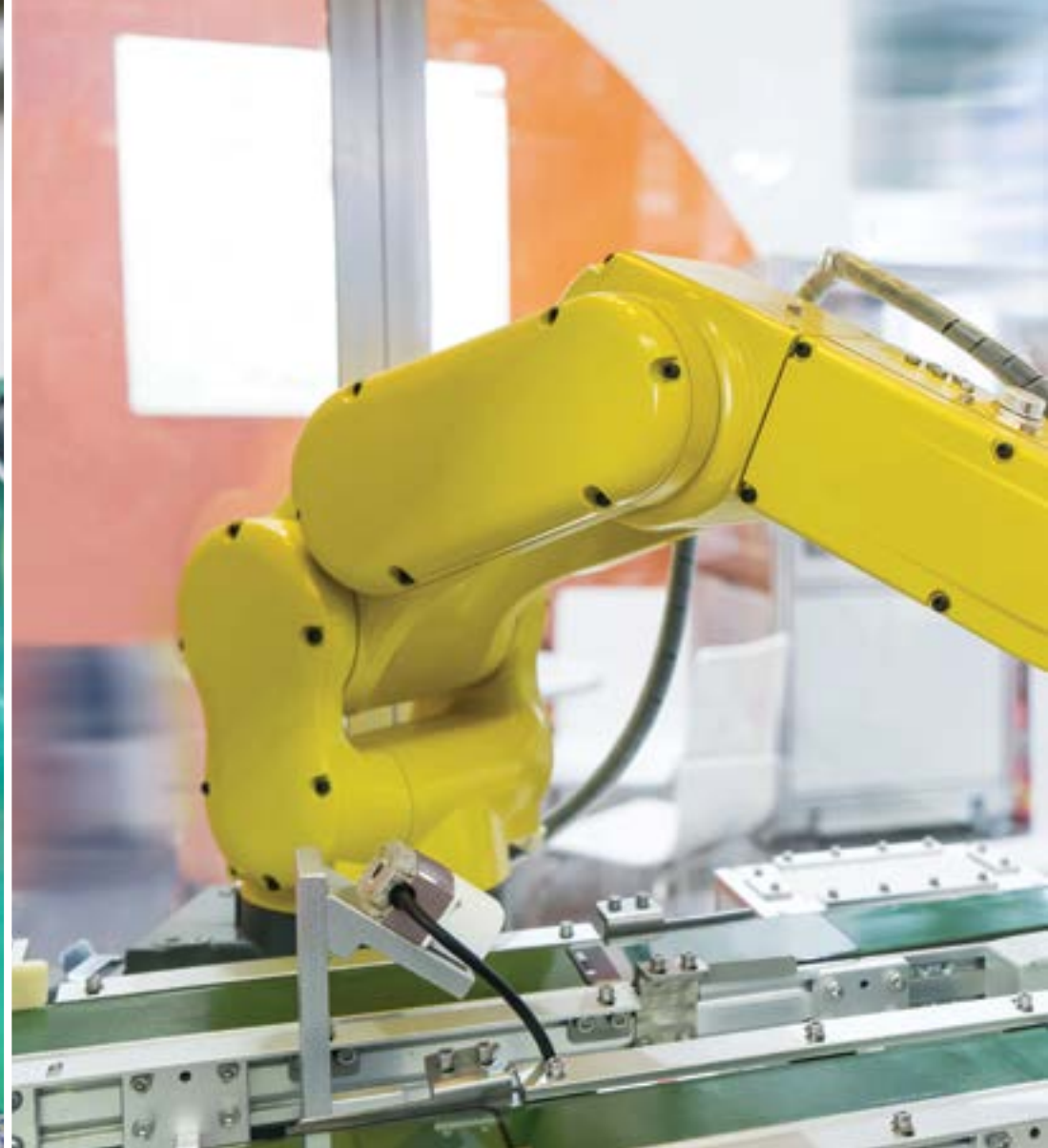

Mobile Device Production

Mobile device production requires assembling and inspecting very small parts in tight spaces. Machines in this industry require reliable and compact equipment that does not get in the way of the process and allows machines and workers to complete tasks effectively. Banner Engineering offers a wide variety of compact machine safety equipment, lighting and indication, and sensor and vision products to ensure the safety, quality, and efficiency of production processes.

Solutions for Mobile Device Production

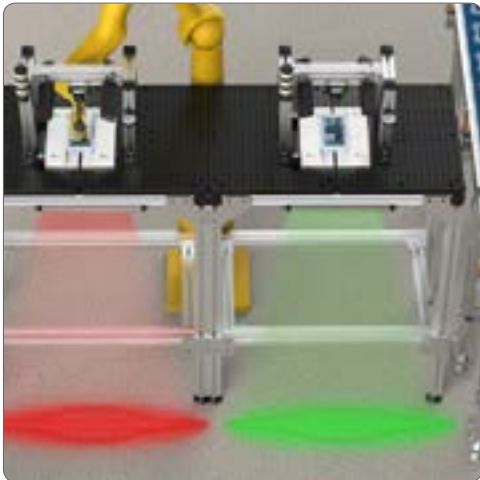

see page 56

Operator Guidance at Robotic Assembly Station

Challenge

- Quickly identify assembly errors
- Maintain a continuous workflow
- Operate in challenging environment

Key Features

- Combines brilliant, bright illumination and high-visibility indication in one device
- Three- and five-color models available
- Rugged, water-resistant IP66, IP67 and IP69K construction

Featured Solution

WLS28 Series LED Strip Lights with EZ-STATUS®

Other Solutions

WLS15 Series Low-Profile LED Strip Lights with EZ-STATUS®

Key Benefits

- Simplifies installation, operation, and troubleshooting
- Allows operators to focus tasks without diverting attention to monitor status
- Reliable operation in challenging environmental conditions



see page 38

Part Positioning on a Robotic Assembly Station

Challenge

- Verify the presence and position of cell phone board in a nest
- Low optical contrast between target and background
- Small, low-profile target requires high level of precision to verify position
- Minimize interference with processes

Key Features

- Reliable sensing range from 25 up to 610 mm
- Immune to variations in target color, reflectivity, and transparency
- Dual teach mode (intensity + distance) sensing,
- Detects height changes as small as 0.5 mm

Featured Solution

Q4X Series Laser Distance Sensor

Other Solutions

Q5X Series High Power, Mid-Range Laser Measurement Sensor

Key Benefits

- Enables installation in a convenient location away from the line
- Precise measurements ensures proper position
- Detects across a variety of target colors, materials and surfaces based on distance



see page 63

Part Inspection at a Robotic Assembly Station

Challenge

- Confirm presence and orientation of components on a cell phone board
- Complex inspection area with many similar looking components
- Inspection of fine details requires higher resolution camera

Key Features

- Available with a high resolution 5MP imager
- Full runtime editing capability
- Software emulator
- EtherNet/IP™, Modbus/TCP, PROFINET®, and Serial RS-232 communication

Featured Solution

VE Series Smart Camera

Other Solutions

iVu Series Image Sensor

Key Benefits

- Detects very small details to verify that all components are correctly placed and positioned
- Minimize downtime by changing inspection parameters while inspections are in progress
- Build and troubleshoot inspections offline prior to implementation
- Supports seamless integration with existing equipment and IIoT data collection



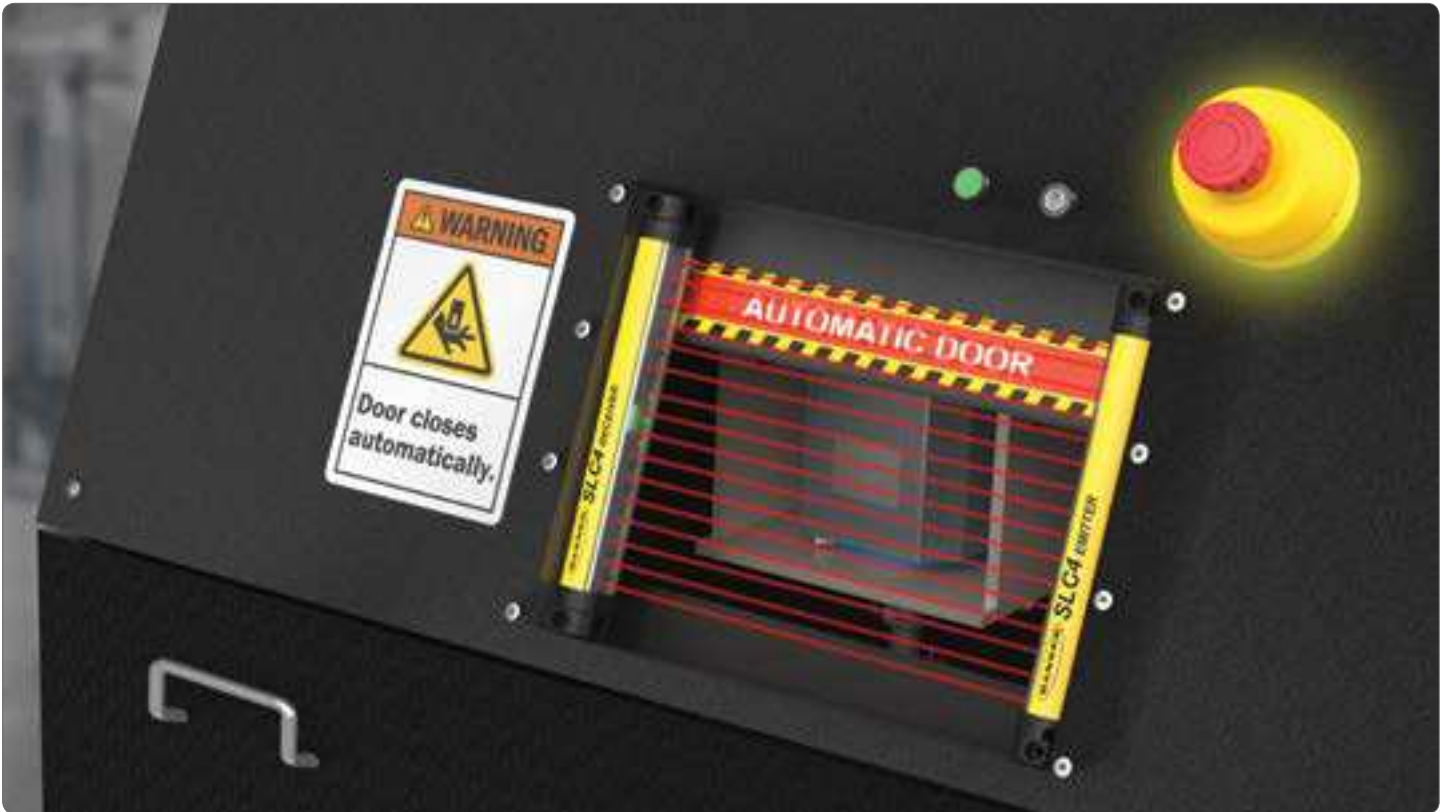

Electronics Final Test

Safeguard Machine Access Point

see page 48

Challenge

- Safeguard access point on a small test machine
- Very fine levels of protection required
- Unobtrusive integration in small area

Featured Solution

SLC4 Series Compact, Low-Profile Type 4 Safety Light Curtains

Other Solutions

LP Series Low-Profile Safety Light Curtains



Key Features

- Defined area heights of 160 mm, 240 mm, and 320 mm
- 0.1 m to 2 m sensing range
- 14 mm or 24 mm resolution models available
- End-to-end sensing design

Key Benefits

- Fits easily in small spaces
- Will not interfere with machine access or operation
- Detects objects as small as a finger or a hand
- Eliminates detection blind zones

Emergency Stop Actuation

see page 52

Challenge

- Provide emergency stop actuation on a small test machine
- Indicate actuator status

Featured Solution

30 mm Mount Emergency Stop Buttons



Key Features

- Pre-assembled one-piece, fully enclosed design with 8-pin quick-disconnect
- Illuminated base: one color solid red or two-color solid yellow with flashing red display

Key Benefits

- Quick easy installation with no assembly or wiring required
- Clear, at-a-glance display of status to quickly resolve issues
- 360° visible indication of E-Stop actuation

Process Initiation

see page 62

Challenge

- Initiate test processes
- Unobtrusive actuation
- Operator strain from repeated actuation

Featured Solution

S22 Pro Series Programmable Multicolor Panel Touch Button

Other Solutions

K30 Core Series Illuminated Touch Buttons



Key Features

- Bright, colorful illuminated display
- Smart capacitive sensing technology
- Terminal connector options
- Solid state electronics

Key Benefits

- At-a-glance display of status to quickly resolve issues
- Requires no physical force to actuate, eliminating hand, wrist, and arm stresses
- Quick, easy installation in panels
- Long operational lifespan with minimal maintenance

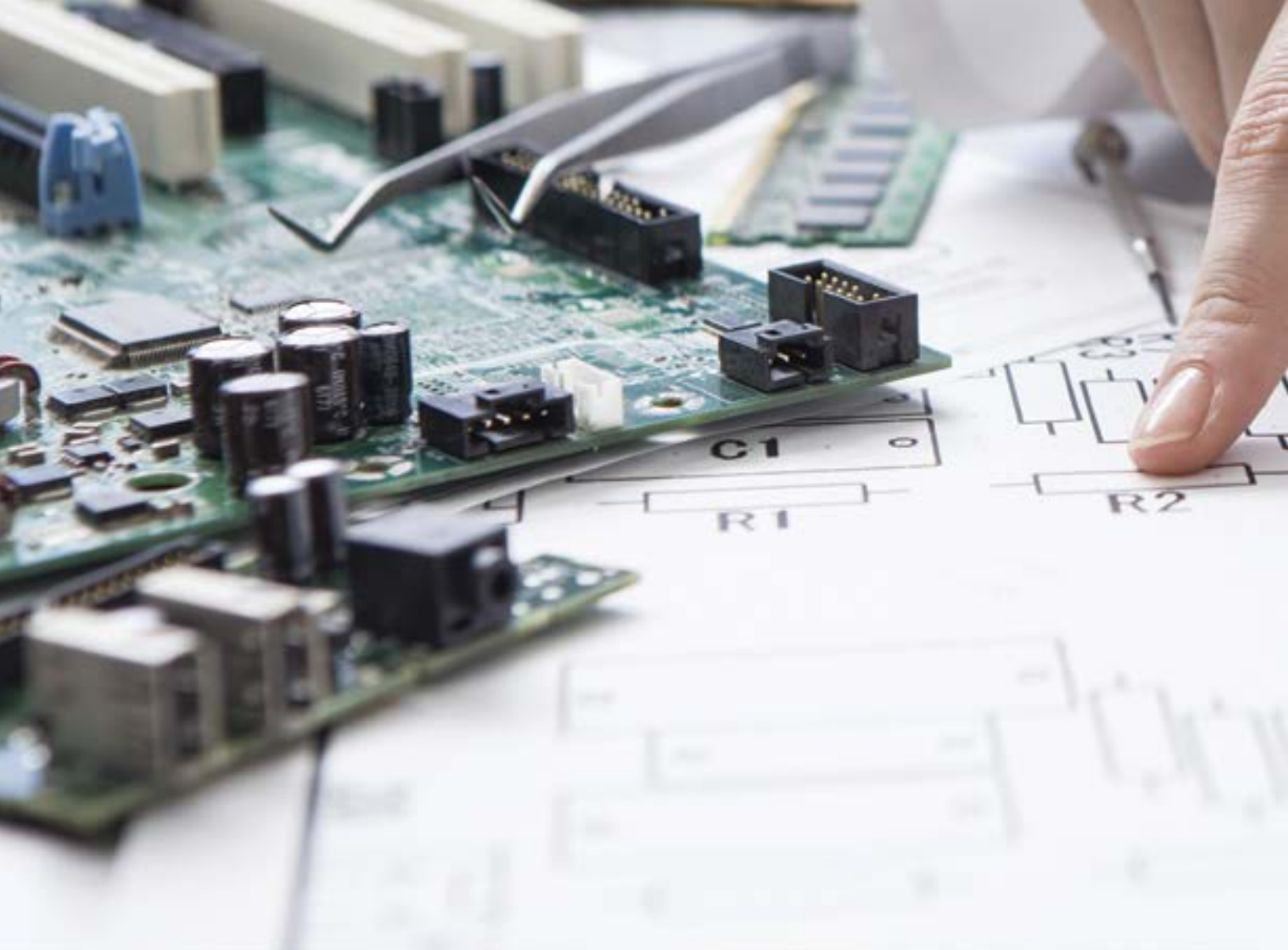

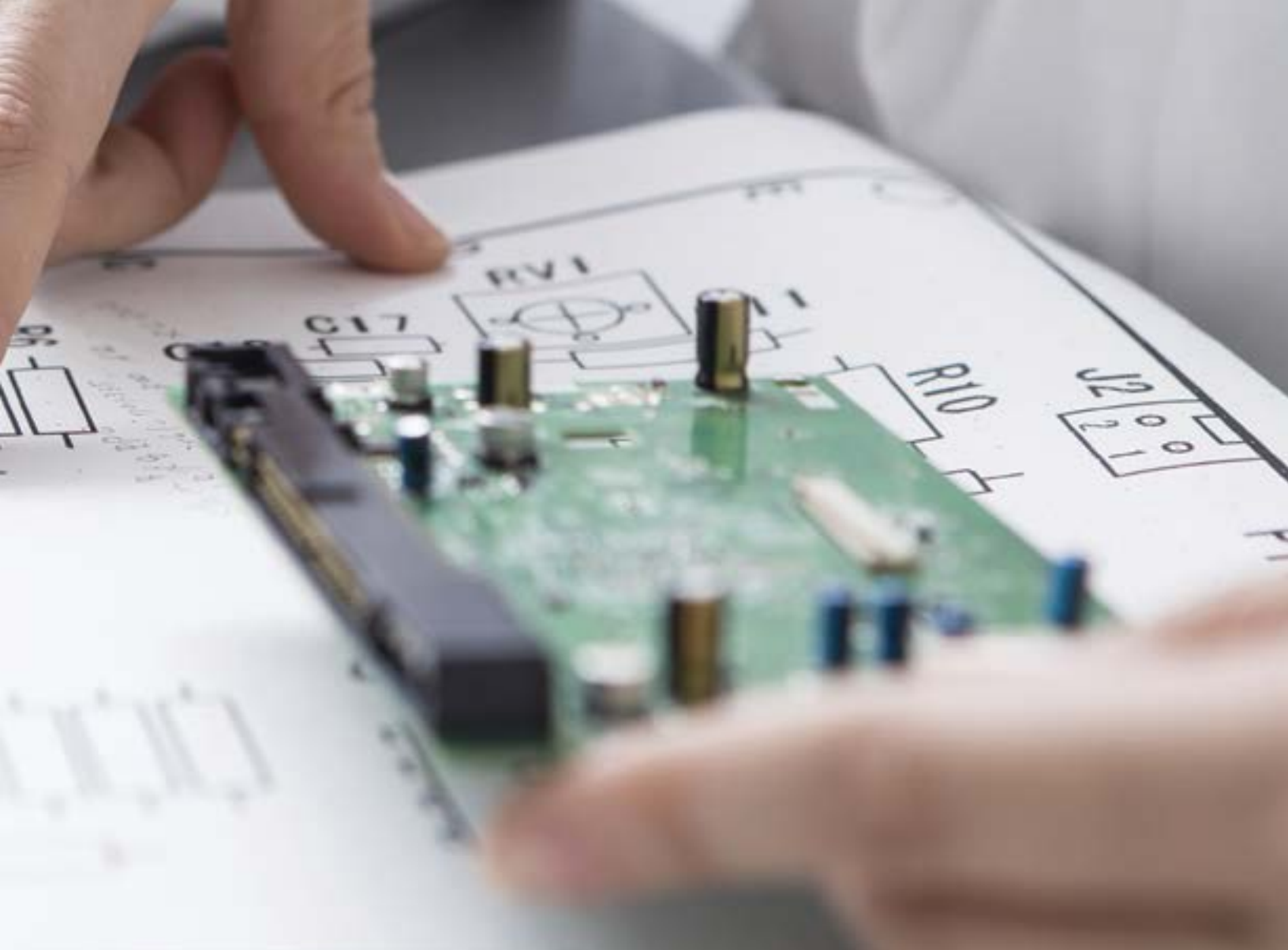

Contract Manufacturing (EMS)

Banner Engineering's broad offering of products and solutions enable electronics equipment manufacturers and electronics manufacturing services (EMS) companies throughout the world to solve their most challenging applications. From energy efficient LED work lighting to a comprehensive offering of safety products, Banner Engineering has the electronics industry experience necessary to solve a variety of applications.

Solutions for Contract Manufacturing (EMS)



see page 60

Monitoring Machine Status

Challenge

- Provide status indication on legacy equipment
- Monitor multiple machines spread out over a wide area
- Improve overall equipment effectiveness
- Maintain a steady workflow

Key Features

- Bright, high-visibility illuminated segments
- Modular design with color, audible, and wireless segments available
- Secure, robust Sure Cross wireless network with up to two miles line of sight signal range

Featured Solution

TL70 Series Modular Tower Lights with Sure Cross® Wireless Communication Segment

Other Solutions

TL70 Series Modular Tower Lights with Sure Cross Wireless Base



Key Benefits

- Provides at-a-glance status indication
- Users can customize functionality adding segments as desired
- Wireless connectivity enables remote monitoring and access to machine performance data
- Quick, easy installation requiring no communication cables to connect devices to the network



see page 43

Verify Presence and Position of Disk

Challenge

- Ensure disk is present and properly positioned in a specific location
- Shiny, reflective surface
- Minimize interference with processes

Key Features

- Reliable sensing range up to 150 mm (Q20) and 600 mm (Q4X)
- Small spot size for precise leading edge detection (Q20 and Q4X)
- Dual teach mode sensing measures the distance to and light intensity from a background condition (Q4X)
- Detects height changes as small as 0.5 mm (Q4X)

Featured Solution

Q20 Series Sensors and Q4X Series Analog Laser Measurement Sensor

Other Solutions

Q3X Series Laser Contrast Sensor and Q4X Series Laser Measurement Sensor



Key Benefits

- Enables installation in a convenient location
- Precise measurements ensures proper position
- Detects across a variety of target colors, materials and surfaces based on distance
- Detects a wide range of objects regardless of target color, reflectivity, and transparency



see page 68

Vibration and Temperature Monitoring on a Motor

Challenge

- Off-line motor testing requires costly downtime and can miss changes between tests
- On-line or dynamic testing may neglect key symptoms that indicate motor decline

Key Features

- Continuously monitor a variety of vibration characteristics and temperature to identify machine problems early
- Communicates data over a secure, reliable Sure Cross® wireless network
- Combines a vibration and temperature sensor, wireless node, and battery power supply in one compact and completely wireless device

Featured Solution

Q45VA All-in-One Vibration and Temperature Sensor and Wireless Node and DXM Series Wireless Controller



Other Solutions

QM30VT Series Vibration and Temperature Sensor, MultiHop Modbus Radio or 1-Wire Serial Node, and DXM Series Wireless Controller

Key Benefits

- Monitor multiple machines in real-time from a convenient location
- Identify errors before a failure can occur by creating real-time alerts to notify operators when vibration thresholds have been exceeded
- All-in-one design eliminates the time and expense of installing separate sensors and nodes



see page 70

Vibration and Current Monitoring on a Motor

Challenge

- Expose machine performance issues
- Identify equipment requiring full spectrum analysis
- Establish more strategic scheduling of equipment maintenance

Key Features

- Combines a wireless radio, antenna, and battery power supply in one compact device
- Preconfigured to work with current transformer and a QM30VT Series vibration and temperature sensor
- Includes 20 amp and a 150 amp current transformer
- Full compatibility with Wireless Solutions Kits and Connected Data Solutions cloud software

Featured Solution

CM Series Condition Monitoring Node, Current Transformer, and QM30VT Vibration and Temperature Sensor



Key Benefits

- Quick, easy deployment: simply connect one or both devices and begin communicating
- Eliminates the hassle and expense of running communication cable to connect devices
- Provides access to real time and historical data and makes it easy to create visualization tools, warnings, and alarms to ensure maximum uptime
- Monitors general health and performance, specific components, and can be used to verify that equipment is ON or OFF, track energy use, and identify power surges



see page 55

Operator Guidance for Electronic Assembly

Challenge

- Assemble multiple parts at one station
- Simplify complicated assembly processes
- Improve assembly accuracy
- Increase product output

Key Features

- Bright, multi-color indication with animation options provide clear communication to guide staff through assembly
- Easy-to-see digital display indicates part count or instructions
- Optical sensor detects hands as they pick pieces
- Very fast response speed for indication of next step in assembly process
- Compatible with DXM700 wireless controller for use on carts and mobile picking stations

Featured Solution

PTL110 Series Pick-to-Light devices



Key Benefits

- Simplifies the build of parts and ensures a high level of quality assurance
- System keeps pace with the speed of the assembler
- Precise picking system supports multiproduct assembly, allowing one assembler to work on different components at the same station
- Monitor for speed and accuracy, production and inventory levels, and respond quickly to quality issues



see page 37

Roll Diameter Measurement

Challenge

- Monitor roll of shrink wrap to alert when product is running out
- Splice new roll on to old roll with minimal downtime
- Ensure proper roll tension to prevent breakage

Key Features

- Dual teach mode sensing measures the distance to and light intensity of the background condition
- 0.1 to 2 m sensing range
- Optional Remote Sensor Display (RSD)

Featured Solution

Q5X Series High Power, Mid-Range Laser Measurement Sensor

Other Solutions

LE Series Laser Displacement Sensor

LTF Series Long-Range Laser Sensor



Key Benefits

- Reliable detection regardless of object color, translucence, or reflectivity
- Accurate measurement reduces waste left on the core
- Simplifies setup and monitoring of sensors in difficult-to-access locations
- Reduces downtime between product changeover



Automated Tray Handling System

Reading Barcodes on JEDEC Trays see page 35

Challenge

- Create record for IC chips being processed
- Space-constrained deployment area
- High-speed process

Featured Solution

ABR Series Imager-Based Barcode Reader



Other Solutions

iVu BCR Series Barcode Reader

Key Features

- Available in models with a WVGA imager or a 1.2 MP imager with standard or polarized windows
- Barcode Manager software with intuitive flowchart programming and advanced capabilities
- Ultracompact housing for even the tightest of spaces
- Factory communication options include Ethernet or USB

Key Benefits

- Reliably reads small, complex, and challenging barcodes
- Quick, easy device setup, management, and monitoring of multiple barcode readers from network-enabled location
- One-piece, ultracompact device fits easily in very small spaces
- Seamless integration with existing equipment and IIoT data collection

Safeguarding Machine Access Points see page 49

Challenge

- Safeguard access to tray processing area
- Requires redundant, self-checking outputs
- Limited space for deployment

Featured Solution

LP Basic Series compact Type 4 safety light curtain



Other Solutions

LP Series full feature compact Type 4 safety light curtain

Key Features

- Low-profile, compact design and multiple mounting options
- Available in nickel-plated housings for ESD-safe applications
- Zone and status indicators plus digital display to indicate number of beams blocked and detailed diagnostics
- End-to-end sensing design

Key Benefits

- Installs easily in very small spaces
- Device can be installed within the machine frame
- Minimizes downtime by making it easy to troubleshoot and quickly resolve issues
- Eliminates detection blind zones

Illuminating Work Area see page 55

Challenge

- Illuminate machine and work area
- Consistent, even illumination over a wide area
- Reduce service and maintenance on light fixtures

Featured Solution

WLB72 Series LED Task Light



Other Solutions

WLB92 Series LED Task Light

Key Features

- Ultra-bright white light with even light distribution
- Rugged metal housing with shatterproof cover
- Robust electronics and circuit design for long product lifetime
- Plug-and-play operation out of the box

Key Benefits

- Increased safety and productivity
- No bulb replacement or other maintenance
- Low installation costs, quick install time
- Fewer fixtures needed to illuminate the whole area



Displays (Clear Object Detection)

A challenging but critical aspect of electronics manufacturing is the ability to reliably and cost-effectively detect clear objects like transparent film, plastic, or glass and other targets with low optical contrast. Banner Engineering offers a wide variety of solutions to clear object detection challenges, including economical photoelectric sensors, versatile fiber optic sensors, and high-power laser sensors to meet any application requirements

Solutions for Display Production



see page 40

Detecting Clear Plastic Material

Challenge

- Detect clear plastic waste material in a bin
- Prevent overfill of material
- Low optical contrast

Key Features

- Polarized lens with coaxial optics
- Three user-selectable thresholds
- Universal housing design with 18 mm threaded lens and multiple mounting options
- Compensates for dust build up and ambient temperature changes

Featured Solution

QS18E Clear Object Detection Sensor



Key Benefits

- Reliably detects a wide range of clear, translucent, or opaque objects
- Detects at any distance from the face of the sensor out to the reflector with no dead zone
- Optimize performance to the type of object being detected
- Versatile, cost-effective and easy-to-use sensor
- Long operational life with only routine maintenance



see page 41

Monitoring Tote Fill Levels

Challenge

- Detect high and low fill levels
- Low optical contrast between waste water and container
- Challenging environmental conditions

Key Features

- Emits a 1450 nm sensing beam that is attenuated by water-based liquids
- Long-range sensing of up to 8 m between emitter and receiver
- Rugged IP67 (NEMA 6) housing and encapsulated electronics

Featured Solution

QS30H2O Series Water Sensor

Other Solutions

DF-G3LIR Long-Range Infrared Water Sensor with Glass Fiber Optic Bundle



Key Benefits

- Reliably detects the presence of any water-based liquid
- Detects liquids in a wide range of different sized containers
- Resists harsh environments



see page 38

Detecting Clear Plastic Film

Challenge

- Detect clear, thin glass sheet
- Low optical contrast
- Machine vibration

Key Features

- Dual teach mode measures distance and light intensity changes compared to a background reference condition
- Robust IP69K-rated stainless steel housing
- Clear intensity readout from angled three-digit display

Featured Solution

Q4X Series Laser Distance Sensor



Key Benefits

- Detects a wide range of objects regardless of color, reflectivity, and transparency
- Easy-to-see feedback simplifies operation and troubleshooting
- Resists aggressive cleaning, mechanical impact, and extreme vibration
- No reflector required



Products

Sensors

LM	36
LE	36
Q5X	37
Q4X	38
Q3X	39
QS18	40
QS30	41
Q12	43
Q20	43
VS8	40
DF-G3	44
DF-D2	45
T30UX	42

Safety

XS26-2	46
SC10	47
SLC4	48
LP Basic	49
RFID Switches	50
Magnetic Switches	51
Hinge Switches	51
E-Stop Button	52

Lighting & Indicators

WLS15	53
WLB32	54
WLS28-2	56
PTL110	55
WLB72	55
TL50	58
TL70	60
K50 Pro	61
S22 Touch	62

Vision

VE Camera	63
iVu	66

Barcode Readers

ABR Series	35
iVu BCR	65

Wireless

DXM	67
Q45	68
QM30VT/ Vibration	69
K50U/Tank level	69
Pressure Nodes	70
Condition Monitoring Nodes	70

LM Series

Compact Precision Laser Measurement Sensor



IO-Link®

- Precise measurements with 0.002-0.004 mm analog resolution
- Fast 0.5 ms response speed and 0.25 ms sampling rate
- Compact housing designed to fit into small spaces
- Thermally stable housing and secure mounting for real-world stability
- IP67 and Grade 316 stainless steel for chemical compatibility
- Optional Remote Sensor Display (RSD) for remote monitoring and setup



SMBLML1

SMBLML2

Series	Range (mm)	Output	Connector
LM	150	KI	QP
	150 = 50-150 80 = 40-80	KI = Discrete with IO-Link and 4 to 20 mA analog	QP = PVC M12 Euro Pigtail QD



5-Pin M12 Euro-Style with Shield

5-Pin Double-Ended M12 Euro-Style with Shield (Male/Female)

MQDEC2-515
MQDEC2-515RA
5 m (15')

MQDEC3-515SS
5 m (15')



IO-Link®

LE Series

Laser Measurement Sensor

- Precise measurements with 0.02 mm resolution
- Ready to measure right out of the box with simple setup
- Two-line, eight-character intuitive display for easy adjustments
- Small spot, visible laser for simple alignment
- Repeatability and accuracy for challenging targets, from metal to black rubber

Family	Range	Output	Laser Class	Connector
LE	550	I	Blank	Q
	550 = 100-1000 mm 250 = 100-400 mm	I = 4 to 20 mA analog and (1) NPN/PNP discrete U = 0 to 10 V analog and (1) NPN/PNP discrete D = (2) NPN/PNP discrete K = Dual Discrete with IO-Link	Blank = Class 2 C1 = Class 1	Blank = 2 m Integral Cable Q = Rotatable M12 Euro QD QP = PVC M12 Euro Pigtail QD W/30 = 9 m Integral Cable

NOTE: Discrete NPN/PNP is user configurable



SMBAMSLEIP
full assembly with plate and protective windows
RWAMSLE
replacement windows
SMBAMSLTFP
mounting plate



SMBLEFA



SMBLEL



SMBLEU



5-Pin M12 Euro-Style with Shield

MQDEC2-515
MQDEC2-515RA
5 m (15')



IO-Link®

Q5X Series

High Power, Mid-Range Laser Measurement Sensor

- Reliable detection of black targets against a black background, black targets against a shiny metal background, clear and reflective objects, multicolor packaging, and targets of all colors
- Dual teach mode measures both distance plus light intensity to solve the most challenging applications
- 270-degree rotatable M12 QD to meet a variety of mounting constraints
- Rated IP67 for reliable performance in wet environments
- Optional Remote Sensor Display (RSD) for remote monitoring and setup

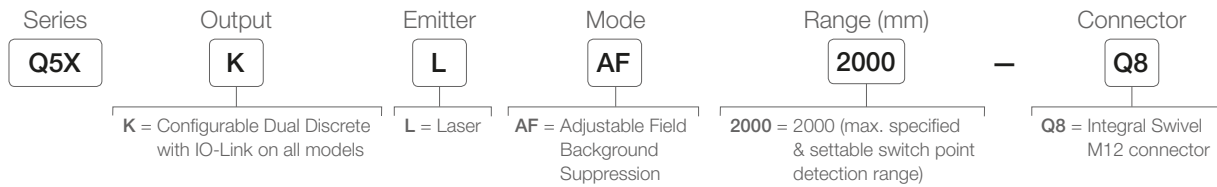

SMBQ5XFAM10



SMBQ5XDT



SMBQ5XM4F



SMBAMSQ5XIPRA



Double-Ended Euro-Style with 5-pin straight male to 4-pin straight female connectors
Required for use between RSD and sensor

MQDC-4501SS
0.3 m (1')
MQDC-4506SS
1.83 m (6')



5-Pin M12 Euro-Style

MQDC-415
MQDC-415RA
5 m (15')



IO-Link®

Q4X Series

Rugged Laser Measurement Sensor

- Save time and money with the Q4X which is ready to measure right out of the box
- A simple user experience from installation to setup
 - Bright spot alignment
 - Three push buttons simplify setup
 - Intuitive menus
- Four-digit display shows distance to target in mm
- FDA-grade stainless steel is suitable for IP69K washdown environments

Threaded

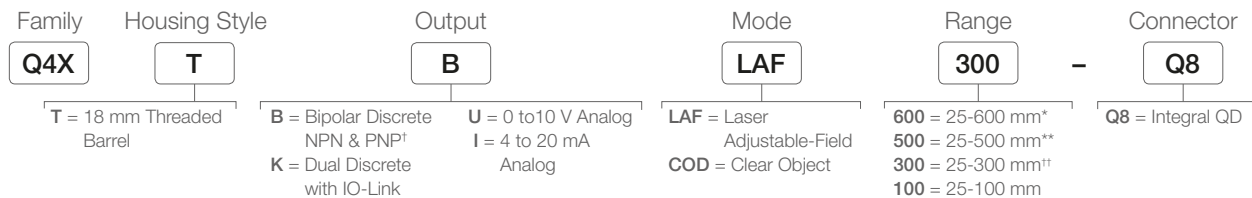

Flush

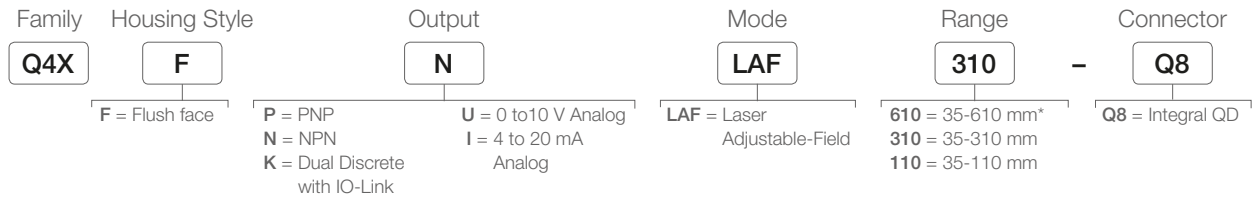

* Only available in Dual Discrete with IO-Link models

† Clear Object models only available with bipolar output

** Not available in Dual Discrete with IO-Link models

†† Clear object only this range



SMBQ4XFA
includes 3/8" bolt for mounting

SMBQ4XFAM10
includes 10 mm bolt for mounting

SMBQ4XFAM12
clamps directly onto industry standard bracket systems of 1/2" or 12 mm rods



SMB18A



SMBAMS18P



5-pin Euro-Style
Used with: Analog models

MQDEC2-515
MQDEC2-515RA
5 m (15')



5-Pin Washdown Euro-Style
Used for: Analog Washdown

MQDCWD-506
2 m (6.5')



4-pin Euro-Style
Used with: NPN, PNP, Dual Discrete

MQDC-415
MQDC-415RA
5 m (15')



5-pin Euro-Style
Used with: Bipolar

MQDC1-515
MQDC1-515RA
5 m (15')



4-Pin Washdown Euro-Style
Used for: NPN, PNP, Dual Discrete

MQDC-WDSS-0415
5 m (15')



5-Pin Washdown Euro-Style
Used for: Bipolar

MQDC-WDSS-0515
5 m (15')

Q3X Series

Laser Contrast Sensor



- High-speed part detection as fast as 250 us, capturing up to 2,000 events per second
- Reliable sensing range up to 300 mm
- Used for challenging presence/absence or orientation detection for applications with small contrast differences
- Rugged, nickel-plated zinc housing suitable even for environments with cutting fluids and oils
- Clear intensity readout from angled three-digit display
- Fixed background suppression models allow for contrast detection in a fixed range while ignoring a background

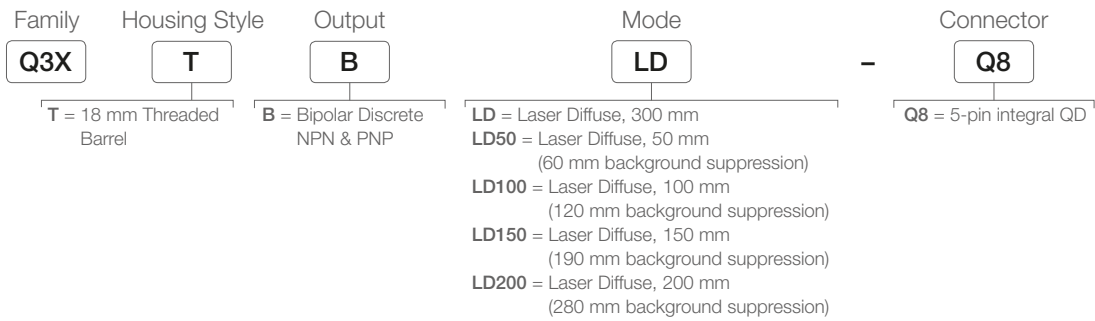

SMBQ4XFA
includes 3/8" bolt for mounting

SMBQ4XFAM10
includes 10 mm bolt for mounting

SMBQ4XFAM12
clamps directly onto industry standard bracket systems of 1/2" or 12 mm rods



SMB18A



SMBAMS18P



5-Pin M12 Euro-Style

MQDC1-515
MQDC1-515RA
5 m (15')

5-Pin M12 Euro-Style Washdown - Stainless Steel

MQDC-WDSS-0515
5 m (15')



QS18 Series

All-Purpose Photoelectric Sensor

- Features a universal housing with an 18 mm threaded lens or side mounts
- Meets IP67 and NEMA 6 standards for harsh environments
- Available in opposed, polarized and non-polarized retroreflective, convergent, regular and wide-angle diffuse, small spot diffuse, laser, ultrasonic, plastic or glass fiber optic, fixed-field and adjustable-field sensing modes
- Offers easy push-button TEACH-mode setup in Expert QS18E and ultrasonic models
- Available in models with IO-Link communication for simplified wiring, installation, preventative maintenance, and sensor backup

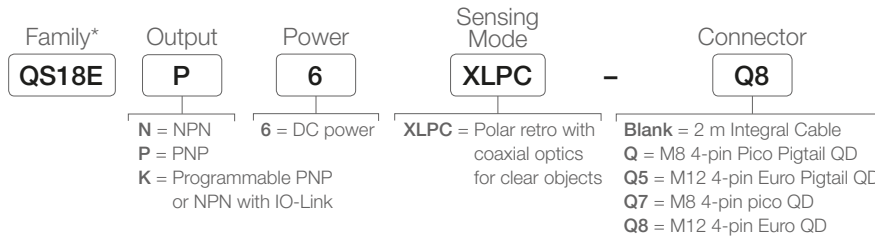
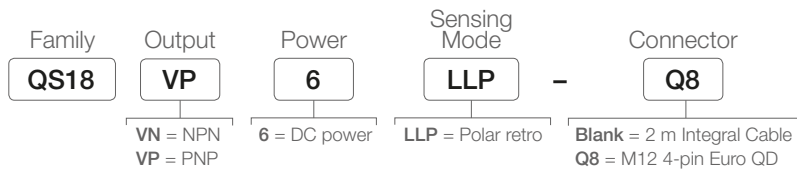

4-Pin M12 Euro-Style

MQDC-415
5 m (15')



4-Pin Pico-Style Straight Right-angle

PKG4M-5
PKW4M-5
5 m (15')

* All models require a reflector



VS8 Series

Miniature Sensor for Precise Detection

- Miniature sensor for installation in the smallest of spaces
- Red laser models provide bright, precise laser light spot for optimum small part detection
- Models with a blue LED reliably detect challenging targets, including dark, reflective, and transparent objects without requiring a reflector
- High switching frequency for detection in even the fastest processes
- Robust, glass-fiber-reinforced plastic housing

Sensing Mode
 Blue LED

Sensing Mode	Range	Output Type	Connection	Model
Blue LED, Fixed 30 mm Background Suppression	2 to 30 mm (0.08 to 1.18 in)	PNP NPN	2 m (6.5 ft) unterminated 4-wire PUR cable	VS8APFF30B* VS8ANFF30B*

* To order the 200 mm (7.8 in) PUR cable model with a 3-pin M8/Pico-style quick disconnect, add suffix "Q3" to the model number. For example, VS8APFF15Q3



4-Pin M12 Euro-Style

MQDC-415
5 m (15')

Pico-Style Straight Right-angle

3-Pin 4-Pin
 PKG3M-5 PKG4M-5
 PKW3M-5 PKW4M-5
 5 m (15') 5 m (15')



QS30 Water Detection

DC-Operated Long-Range Sensors

- Detects waterbased liquids in translucent and opaque bottles
- Ability to work reliably in low contrast applications
- 1450 nm infrared wavelength to enhance contrast of clear liquids

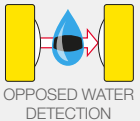
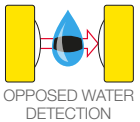
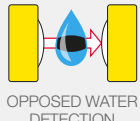
Sensing Mode ⇒ Infrared LED	Range	Connection	Output Type	Model
 <p>OPPOSED WATER DETECTION</p>	4 m	2 m	—	QS30EXH20 Emitter
		5-pin Euro Pigtail QD	—	QS30EXH20Q5 Emitter
		2 m	Bipolar NPN/PNP LO	QS30ARXH20
		5-pin Euro Pigtail QD	Bipolar NPN/PNP DO	QS30ARXH20Q5
		2 m	Bipolar NPN/PNP DO	QS30RRXH20
		5-pin Euro Pigtail QD	Analog 0-10 V	QS30RRXH20Q5
 <p>OPPOSED WATER DETECTION</p>	2 m	2 m	Bipolar NPN/PNP LO	QS30ARH20
		5-pin Euro Pigtail QD	Bipolar NPN/PNP LO	QS30ARH20Q5
		2 m	Bipolar NPN/PNP DO	QS30RRH20
		5-pin Euro Pigtail QD	Bipolar NPN/PNP DO	QS30RRH20Q5
 <p>SUPER HIGH-POWER OPPOSED WATER DETECTION</p>	8 m	2 m	—	QS30EXSH20 Emitter
		5-pin Euro Pigtail QD	—	QS30EXSH20Q5 Emitter
		2 m	Bipolar NPN/PNP LO	QS30ARXSH20
		5-pin Euro Pigtail QD	Bipolar NPN/PNP LO	QS30ARXSH20Q5
		2 m	Bipolar NPN/PNP DO	QS30RRXSH20
5-pin Euro Pigtail QD	Bipolar NPN/PNP DO	QS30RRXSH20Q5		



SMBQS30L



SMBQS30LT



5-Pin M12 Euro-Style

MQDC1-515
5 m (15')



SMBQS30Y



SMB30SC



T30UX Series

Right-Angle, Long-Range Ultrasonic Sensors

- Built-in temperature compensation for high-accuracy across a wide range of ambient temperatures
- Resists harsh environments with rugged IP67 (NEMA 6) housing and fully encapsulated electronics
- Push-button and remote TEACH-mode programming with an external switch, computer or controller for added security and convenience

Range	Frequency	Connection	Response Time	Output	Models*
100 mm to 1 m	224 kHz	2 m 4-Pin Euro QD	45 ms	Discrete: NPN, PNP, NO, NC, Selectable	T30UXDA T30UXDAQ8
200 mm to 2 m	174 kHz	2 m 4-Pin Euro QD	92 ms	Discrete: NPN, PNP, NO, NC, Selectable	T30UXDB T30UXDBQ8
300 mm to 3 m	114 kHz	2 m 4-Pin Euro QD	135 ms	Discrete: NPN, PNP, NO, NC, Selectable	T30UXDC T30UXDCQ8
100 mm to 1 m	224 kHz	2 m 4-Pin Euro QD	Selectable 45 or 105 ms	Analog: 0 to 10 V dc	T30UXUA T30UXUAQ8
100 mm to 1 m	224 kHz	2 m 4-Pin Euro QD	Selectable 45 or 105 ms	Analog: 4 to 20 mA	T30UXIA T30UXIAQ8
200 mm to 2 m	174 kHz	2 m 4-Pin Euro QD	Selectable 92 or 222 ms	Analog: 0 to 10 V dc	T30UXUB T30UXUBQ8
200 mm to 2 m	174 kHz	2 m 4-Pin Euro QD	Selectable 92 or 222 ms	Analog: 4 to 20 mA	T30UXIB T30UXIBQ8
300 mm to 3 m	114 kHz	2 m 4-Pin Euro QD	Selectable 135 or 318 ms	Analog: 0 to 10 V dc	T30UXUC T30UXUCQ8
300 mm to 3 m	114 kHz	2 m 4-Pin Euro QD	Selectable 135 or 318 ms	Analog: 4 to 20 mA	T30UXIC T30UXICQ8



SMB30A



SMB30FA..



SMB1815SF



4-Pin M12 Euro-Style
with Shield

MQDEC2-415
MQDEC2-415RA
5 m (15')



Q12 Series

Miniature Self-Contained Sensor

- Delivers powerful sensing performance in extremely confined areas
- Rated IP67 for use in the widest range of locations and applications
- Available in models with rugged, sealed housing or PFA chemical-resistant jacket
- Uses unique overmolded design for enhanced durability and shielding

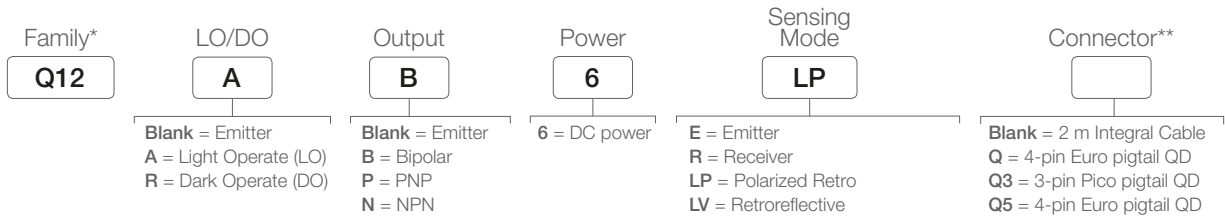

* For black housing, add prefix D to the model number, for example DQ12AB6FF15
 ** For 9 m (30 ft) cable, add suffix W/30 to the model number, for example, Q126E W/30



4-Pin Euro-Style
(for Q5 models)

Pico-Style
Straight
Right-angle

MQDC-415
MQDC-415RA
5 m (15')

3-Pin
PKG3M-5
PKW3M-5
5 m (15')

4-Pin
PKG4M-5
PKW4M-5
5 m (15')



Q20 Series

Industry Standard Global Housing

- Versatile sensor with a universal rectangular housing and multiple mounting options, making it ideal for global manufacturing
- Rated to 1200 psi for use in washdown environments
- Enhanced design for noise immunity and crosstalk avoidance
- Visible red beam for easy alignment on most models

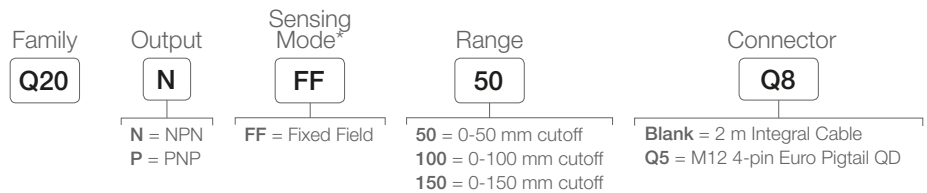

4-Pin Euro-Style
(for Q5 models)

4-Pin Pico-Style
Straight
Right-angle

4-Pin Pico-Style Snap-On
(for Q7 models)
Straight
Right-angle

MQDC-415
MQDC-415RA
5 m (15')

PKG4M-5
PKW4M-5
5 m (15')

PKG4-2
PKW4Z-2
2 m (6.5')



IO-Link®

DF-G3 Series

Long-Range Fiber Optic Amplifiers

- World-class long-range sensing capability, more than 3 m (10 ft) with opposed mode fibers
- Easy to read dual digital displays show both signal level and threshold simultaneously
- Cross-talk avoidance function allows seven inspections in dense sensing point applications
- Models with IO-Link enable a point-to-point communication link between a master device and a sensor, facilitating remote monitoring, teaching, and configuration
- Operator control of the sensitivity (hysteresis) provides additional detection sensitivity, or a stabilized output depending on the application details

IO-Link

Sensing Beam Color	Range	Connection	Output	Models
➔ Visible Red, 635 nm	3,000 mm	2 m	Channel1: IO-Link, push/pull Channel2: PNP only output, or input	DF-G3-KD-2M
➔ Infrared, 850 nm	6,000 mm	2 m	Channel1: IO-Link, push/pull Channel2: PNP only output, or input	DF-G3IR-KD-2M

Analog

Sensing Beam Color	Range	Connection	Analog Output	NPN Models	PNP Models
➔ Visible Red	3,000 mm	2 m	Voltage: 0-10 V DC	DF-G3-NU-2M	DF-G3-PU-2M
			Current: 4-20 mA	DF-G3-NI-2M	DF-G3-PI-2M
➔ Infrared, 850 nm	6,000 mm	2 m	Voltage: 0-10 V DC	DF-G3IR-NU-2M	DF-G3IR-PU-2M
			Current: 4-20 mA	DF-G3IR-NI-2M	DF-G3IR-PI-2M

Single Output

Sensing Beam Color	Range	Connection	NPN Models	PNP Models
➔ Visible Red	3,000 mm	2 m	DF-G3-NS-2M	DF-G3-PS-2M
➔ Infrared, 850 nm	6,000 mm	2 m	DF-G3IR-NS-2M	DF-G3IR-PS-2M

Dual Output

Sensing Beam Color	Range	Connection	NPN Models	PNP Models
➔ Visible Red	3,000 mm	2 m	DF-G3-ND-2M	DF-G3-PD-2M
➔ Infrared, 850 nm	6,000 mm	2 m	DF-G3IR-ND-2M	DF-G3IR-PD-2M

* Only 2 m (6.5 ft) PVC cable models are listed. To order M8 Pico pigtail, change suffix "2M" to "Q3" (for example, DF-G3-NU-Q3).
To order M12 Euro pigtail, change suffix "2M" to "Q5" (for example, DF-G3-NU-Q5).





DF-G2 Series

High-Speed Fiber Optic Amplifier

- Best in class response speeds of 10 μ s, 15 μ s, 50 μ s, 250 μ s, 500 μ s, and 1000 μ s
- Easy-to-read dual digital displays show signal level and threshold values
- Simple user interface ensures easy sensor set-up and programming via displays and switches/buttons or remote input teach wire
- Expert TEACH and SET methods ensure optimal gain and threshold for all applications, especially for high speed or low contrast applications
- Thermally stable electronics shortens start-up time and maintains signal stability during operation
- Economy display mode reduces amplifier power consumption by 25%
- Cross talk avoidance algorithm allows two sensors to operate in close proximity

IO-Link

Sensing Beam Color	Range**	Connection*	Channel 1 Output	Channel 2 Output	Model*
Visible red	1100 mm	150 mm (6 in) PVC pigtail, M12 Euro, 5-pin	IO-Link, push/pull	PNP only, or input	DF-G2-KD-Q5
Infrared†	2100 mm	150 mm (6 in) PVC pigtail, M12 Euro, 5-pin	IO-Link, push/pull	PNP only, or input	DF-G2IR-KD-Q5

DF-G2: High-Speed Single Discrete Output

Sensing Beam Color	Range	Connection	NPN Model	PNP Model
Visible red	Range varies by response speed used, gain setting, target light source intensity, ambient light level and with fiber optics used.	2 m	DF-G2-NS-2M	DF-G2-PS-2M
		9 m	DF-G2-NS-9M	DF-G2-PS-9M
		150 mm (6 in) PVC pigtail, M8 Pico connector, 4-pin	DF-G2-NS-Q3	DF-G2-PS-Q3
		150 mm (6 in) PVC pigtail, M12 Euro QD connector, 4-pin	DF-G2-NS-Q5	DF-G2-PS-Q5
		Integral M8 Pico, 4-pin	DF-G2-NS-Q7	DF-G2-PS-Q7

DF-G2 Color LED

Sensing Beam Color	Range	Connection*	NPN Models	PNP Models
Infrared†	190% of Visible Red Range	2 m	DF-G2IR-NS-2M	DF-G2IR-PS-2M
Broad spectrum white	50% of Visible Red Range	2 m	DF-G2W-NS-2M	DF-G2W-PS-2M
Visible green	60% of Visible Red Range	2 m	DF-G2G-NS-2M	DF-G2G-PS-2M
Visible blue	70% of Visible Red Range	2 m	DF-G2B-NS-2M	DF-G2B-PS-2M

* Only 2 m (6.5 ft) PVC cable models are listed. To order M8 Pico pigtail, change suffix "2M" to "Q3" (for example, DF-G3-NU-Q3). To order M12 Euro pigtail, change suffix "2M" to "Q5" (for example, DF-G3-NU-Q5).

** Excess gain = 1, Long Range response speed, opposed mode sensing. PIT46U plastic fiber used for visible LED models, IT.83.3ST5M6 glass fiber used for IR model

† IR models require T5 terminated glass fiber optic cables



DIN-35..



SA-DIN-BRACKET



SA-DIN-CLAMP
Mounting Clamp



4-pin Euro QD for Q8 or Q5 models

MQDC-415
5 m (15')
MQDC-415RA
5 m (15')



4-pin Pico QD for Q7 models
Straight snap-on connector
Right-angle snap-on connector

PKG4-2
2 m (6')
PKW4Z-2
2 m (6')



XS26-2

Expandable Safety Controller

- PC Configurable: Flexible and easy-to-use
- Safety Inputs: 26 (base unit) up to 154
- Independently controlled Safety Outputs: up to 68, 0.5A to 6A each
- Convertible Safety Inputs: 8 (Base Unit) up to 40
- LCD Display for easy troubleshooting
- Industrial Ethernet



Model*	Description	Inputs/ Convertible	Independently Controlled Safe Outputs	Max.Safety Output Rating	Model*	Description	Inputs/ Convertible	Independently Controlled Safe Outputs	Max.Safety Output Rating
XS26-2d XS26-2de	Base Controller with LCD	26/8	2	0.5A PNP @24 V dc	XS2so	Safety Output Module	NA	2	0.75A PNP @24 V dc
XS26-2 XS26-2e	Base Controller	26/8	2	0.5A PNP @24 V dc	XS4so	Safety Output Module	NA	4	0.5A PNP @24 V dc
XS8si	Safety Input Module	8/2	NA	NA	XS1ro	Safety Relay Output Module	NA	1	6A; 2 NO, 1 NC aux
XS16si	Safety Input Module	16/4	NA	NA	XS2ro	Safety Relay Output Module	NA	2	6A; 2 NO, 1 NC aux

* Models operate at 24 V dc +/- 20%



SC-XM3
Memory Card



SC-XMP2
Programming Tool
for SC-XM2



SC-USB2
USB Cable for PC configuration
of SC26/XS26



SC10

Hybrid Safety Controller plus 2 Safety Relays

- PC Configurable: Flexible and easy-to-use
- Safety Inputs: up to 10; up to 14 using Automatic Terminal Optimization (ATO)
- Independently controlled Safety Outputs: 2, 6A each
- Convertible Safety Inputs: 4
- Terminal LEDs for easy troubleshooting
- Industrial Ethernet



Model*	Description	Inputs/Convertible	Independently Controlled Safe Outputs	Max.Safety Output Rating
SC10-2roe 	Base Controller	10/4	2	6A; 3 NO

* Models operate at 24 V dc +/- 20%



Store SC-XM3 memory card directly on SC10

SC-XM3

Fast Programming and Swapout

- Backup copy of configuration, password, network settings
- Download configuration without a PC; Save time during panel build
- Fast swapout to minimize downtime at swapout



SC-USB2
USB Cable for PC configuration of SC10



SC-XM3
Memory Card



SLC4 Series

Basic Feature, Very Compact Type 4 Safety Light Curtain

- Basic models with limited options for additional value on simple applications
- Very compact aluminum housing with IP65 polycarbonate enclosure for smaller production machines
- End-to-end sensing (no blind zone)
- Highly visible alignment and diagnostic indicators
- Available in 14 or 24 mm resolutions (detection capability)
- Defined areas of 160, 240 and 320 mm
- 2 m maximum sensing range
- Integral 300 mm M12 QD Pigtail included

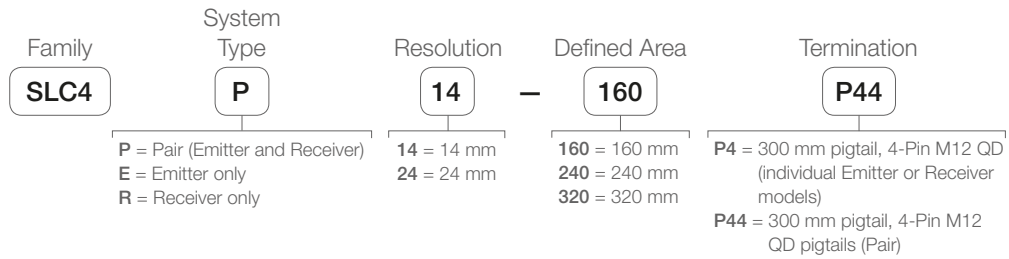

SLC4A-MBK-10



SLC4A-MBK-11



SLC4A-MBK-12



LP Basic

Basic Feature, Very Compact Type 4 Safety Light Curtain

- 4 meter range
- 14 and 25 mm resolution
- IP54 rated
- Defined areas from 270 to 690 mm in 140 mm increments
- Basic functionality auto start/restart (trip output)
- "RD" M12 pigtail and brackets ordered separately

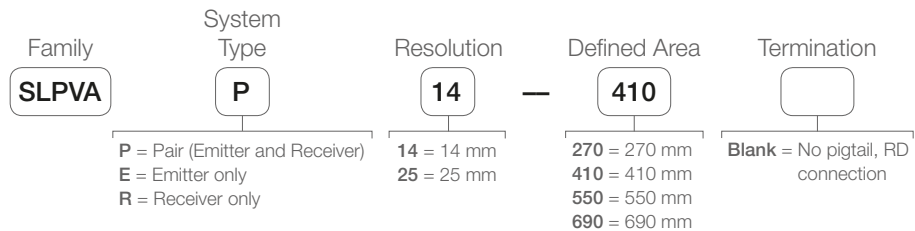

"RD" to M12 Pigtail
Euro-Style M12 Male QD to LP Custom "RD" Connector

DELPE-51D (5-pin)
0.3 m (1 ft)
DELPE-81D (8-pin)
0.3 m (1 ft)



LPA-MBK-10



LPA-MBK-16



LPA-MBK-11



LPA-MBK-12



8-PIN RD Cordsets

RDLS-815
4.6 m (15')



8-pin M12 Euro-Style

QDE-850D
15.2 m (50')



5-pin M12 Euro-Style

QDE-550D
15.2 m (50')



RFID Switches

Non-Contact

- Single and cascade models available to protect one or multiple entry points
- Status and performance data from each sensor in a cascade chain is available using In-Series Diagnostics (ISD) and can be accessed with an HMI or similar device
- On-sensor LED indicator provides at-a-glance status information
- Cascade up to 32 sensors in a series using a standard 4-wire cable with M12 connectors, T-adapters, and an end plug
- Tamper resistance to meet the needs of any application with unique, high, and low code models
- Achieves Cat 4, PL e, or SIL CL 3 safety ratings alone or in a cascade chain
- Rugged, IP69 construction withstands exposure to high-pressure, high-temperature washdown
- High tolerance (10 mm) to misalignment enables reliable performance in challenging industrial environments where machine vibration and impact are possible

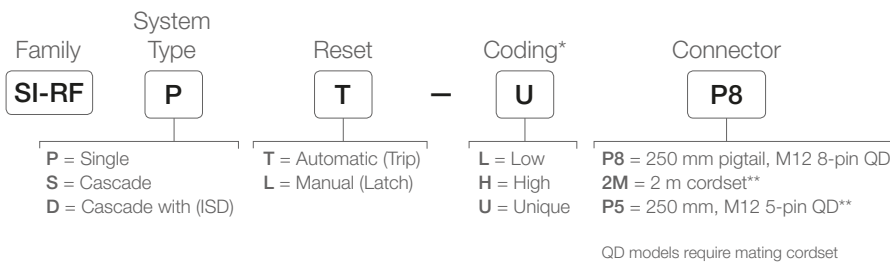

NOTE: SI-RF-A Actuator is required to complete a sensor solution. Ordered separately.

* Tamper Resistant Coding

Low (L)—The SI-RF Safety Switch accepts any SI-RF-A actuator

High (H)—The SI-RF Safety Switch only accepts the last taught-in actuator, a maximum of 12 teach-in processes are possible

Unique (U)—The SI-RF Safety Switch only accepts the taught-in actuator, and only one teach-in process is possible

** Available on single models only

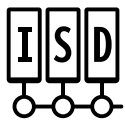

In-Series Diagnostics (ISD) provides users with status and performance data from each sensor in a cascade chain. The ISD data collected is converted to IO-Link so it can be accessed with an HMI or similar device. Users receive notification when an event has occurred as well as where in the series the event occurred. Events include the opening or closing of a door, door misalignment, wrong actuator, and a number of sensor health attributes.



ISD to IO-Link Module

Access comprehensive diagnostic information for each sensor and for the entire system (string of switches) directly via IO-Link or an IO-Link Master with gateway or via a laptop with USB interface.

- Time and cost savings during commissioning, maintenance and fault investigation
- Protection against unexpected machine stops through pre-fault detection
- Basic information, such as switch safety input and safety output status, can be quickly obtained
- Extended diagnostic information and fault information can also be obtained as needed

Model	Output	Interface
SI-RFA-DM1	8 digital outputs; 1 diagnostic circuit	IO-LINK and USB 2.0

SI-RFA-TS

T-Adapter for series connecting switches
4-pin to 8-pin to 4-pin

SI-RFA-P

Termination plug

SI-RFA-TK

T-Adapter for local reset button
8-pin to 4-pin to 8-pin

MQDEC-4xxSS

4-pin Male/Female M12 double-ended cable (straight to straight)

MQDEC-4xxRS

4-pin Male/Female M12 double-ended cable (right-angle to straight)

MQDC-4xx

4-pin female M12 to flying lead cable

USB-USBM-1

1M USB configuration cable for the SI-RFA-DM1





Magnetic Switches

Non-Contact

- Cost-effective non contact solution minimizes device wear and tear, even in applications with persistent use
- 3 to 5 mm misalignment tolerance
- A single magnetic pair can achieve up to Category 4/PLe safety rating
- Coded magnets minimize the potential for intentional defeat
- Available in cable or QD models

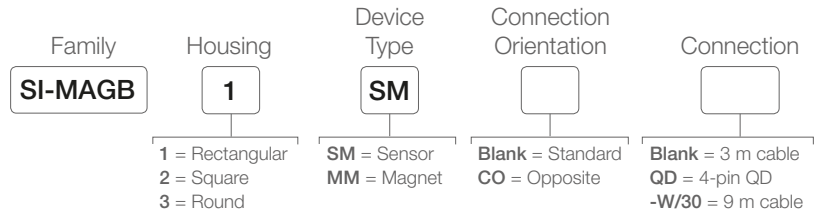

NOTE: When ordering housing 1 or 2 with a QD connection, you will receive an M8 Pico connector. When ordering housing 3 with a QD connection you will receive an M12 Euro connector.

QD models require mating cordset



Hinge Switches

One-Piece Sensor and Actuator with Hinge Function

- Mounts at the axis of a swinging guard where the possibility of misalignment is at its lowest, minimizing the opportunity for nuisance trips
- Achieves Category 4/PLe safety rating with two switches deployed
- Once set, the switch point setting mechanism is fully concealed within the switch, preventing access and complicating any attempts to bypass safety functions
- Available in stainless steel, IP69-rated models that resist high-pressure, high-temperature washdown and similar challenges
- Hinge switches are similar in appearance to standard door hinges, making them completely inconspicuous once installed
- One piece device installs quickly with no need to align the switch and actuator

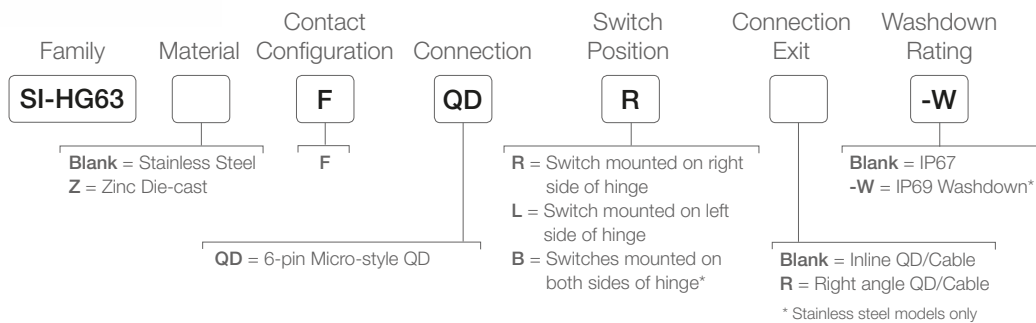



E-Stop Button

Illuminated 30 mm Mount

- Illumination allows for easy identification of which E-stop has been activated
- Easy installation and no assembly or individual wiring required
- Push-to-stop, twist-to-release or pull-to-release operation per IEC 60947-5-5
- Compliant with ANSI B11.19, ANSI NFPA79 and IEC/EN 60204-1 Emergency Stop requirements
- Incorporate with OTB/STB optical touch button for a simplified operator station that does not require an additional enclosure.
- “Safe Break Action” ensures NC contacts will open if the contact block is damaged or separated from the actuator
- Internal electronics automatically change the color from the on state to the off state when the button is pressed

Description	Illumination	Models
2NC / 1NO (PNP)	YEL/RED-Flash/Solid	SSA-EB1PLYR-12ECQ8
2NC / 1NO (PNP)	GREEN/RED-Flash/Solid	SSA-EB1PLGR-12ECQ8
2NC / 1NO (PNP)	OFF/RED-Flash/Solid	SSA-EB1PLXR-12ECQ8
2NC / 1NO (PNP)	OFF/RED-Flash/Solid, with 60 mm button	SSA-EB2PLXR-12ECQ8
2NC / 1NO (PNP)	OFF/RED-Solid/Solid	SSA-EB1PL-12ECQ8
2NC – Safety BUS node compatible	YEL/RED-Flash	SSA-EB1PLYR-02ECQ5A
2NC – Safety BUS node compatible	OFF/RED-Flash	SSA-EB1PLXR-02ECQ5A
2NC – Safety BUS node compatible	OFF/RED-Solid	SSA-EB1PL-02ECQ5A
2NC – Safety BUS node compatible	Illuminated button, OFF (armed), RED (solid, PUSH ON)	SSA-EB1PL2-02ECQ5A
2NC – Safety BUS node compatible	YEL/RED-Flash	SSA-EB1PLYR-02ECQ5B
2NC – Safety BUS node compatible	OFF/RED-Flash	SSA-EB1PLXR-02ECQ5B
2NC – Safety BUS node compatible	OFF/RED-Solid	SSA-EB1PL-02ECQ5B
2NC – Safety BUS node compatible	Illuminated button, OFF (armed) RED (solid, PUSH ON)	SSA-EB1PL2-02ECQ5B

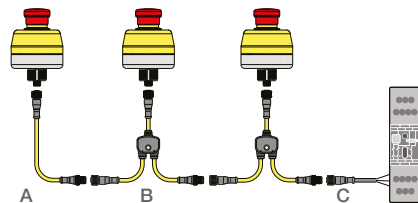

SSA-MBK-EEC1



SSA-MBK-EEC2



SSA-MBK-EEC3



SSA-EB1P-ECWC
Washdown cover



(A)
Euro-Style
Double-ended
male/female



(B)
Euro-Style
Straight
splitter



(C)
M12/Euro-Style
Shielded

M12/Euro-Style
Straight female,
non-shielded

5-Pin

DEE2R-53D
0.9 m (3')

8-Pin

DEE2R-83D
0.9 m (3')

4-Pin

CSS-M12F43M12M41M12F41
0.9 m (3')

8-Pin

CSS-M12F83M12M81M12F81
0.9 m (3')

4-Pin

MQDC-415
5 m (15')
MQDC-415RA
5 m (15')

8-Pin

MQDC2S-815
5 m (15')
MQDC2S-815RA
5 m (15')

SXA-815D
5 m (15')



WLS15 Series

Low Profile LED Strip Light

- Improves visibility, safety, and efficiency
- 15 mm low profile fits in tight spaces that other lights cannot
- Installs in minutes without impacting existing application framework
- Single-color and dual-color with EZ-STATUS® available
- EZ-STATUS® combines illumination and multiple indication capabilities in a single device

Single-Color Models

Family	Cascadable	Color	Length (mm)	Window	Construction	Connector
WLS15	X	DW	0360	D	S	C2
C = Cascadable X = Non Cascadable		DW = Daylight White WW = Warm White	0220 0640 0360 0920 0500 1200	D = Diffuse	S = Sealed (IP66, IP67)	C2 = 2 m Integral QP = 150 mm Integral Euro QD QS = 150 mm Integral cable with Deutsch DTM

Models with a QD or Deutsch DTM connector require a mating cordset

Dual-Color Models

Family	Cascadable	Color 1	Color 2	Length (mm)	Window	Construction	Connector
WLS15	X	W	R	0360	D	S	C2
C = Cascadable X = Non Cascadable		W = Daylight White B = Blue G = Green	R = Red Y = Yellow A = Amber	0220 0640 0360 0920 0500 1200	D = Diffuse	S = Sealed (IP66, IP67)	C2 = 2 m Integral QP = 150 mm Integral Euro QD

Models with a QD connector require a mating cordset



LMBWLS15-150S

LMBWLS15



LMBWLS15MAG

LMBWLS15TF (Tape)



PSW-24-1

Power Supply (Adapters included)



4-Pin Euro-Style

MQDC-415
5 m (15')
MQDC-415RA
5 m (15')



4-Pin Euro-Style Double-ended

Straight/Straight
MQDEC-412SS
3 m (12')



Straight/Right-Angle
MQDEC-412RS
3 m (12')

2-Pin Deutsch Single-ended cordset with straight connectors for single-colored models

DTMC-215
5 m (15')

2-Pin Deutsch Double-ended cordset with straight connectors

DTMEC-206
2 m (6')





WLB32 Series

LED Light Bar

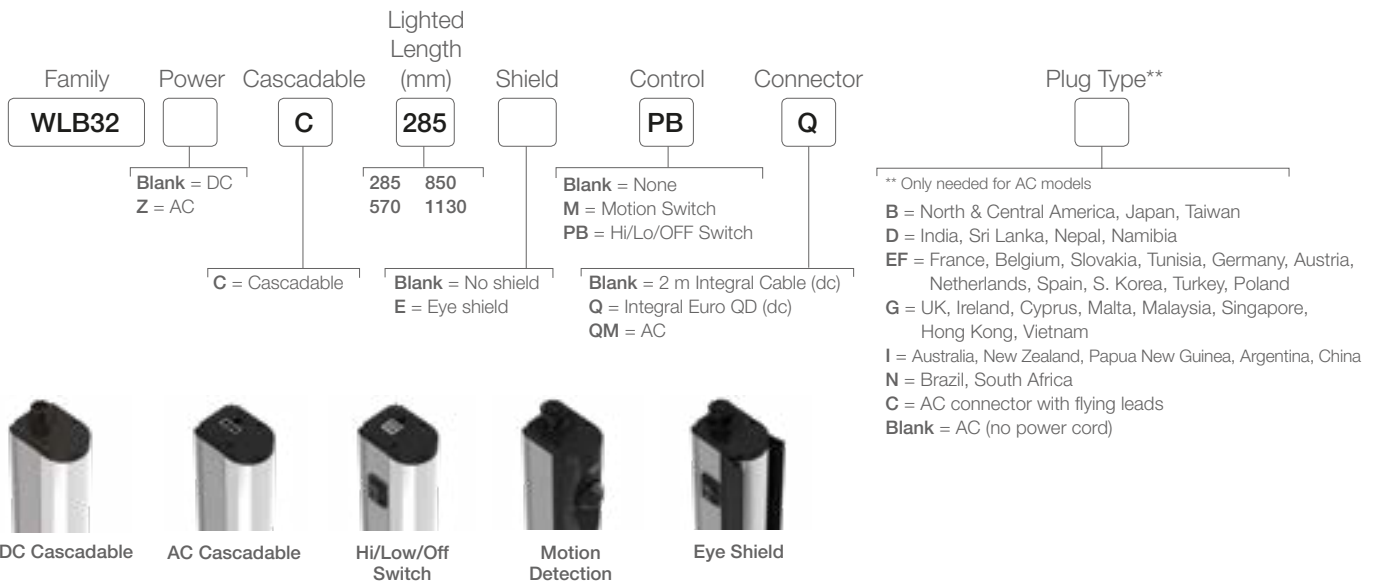
- Banner's WLB32 is an ultra-bright LED fixture that features an even light output for a no glare 'glow'
- Highly energy efficient for overall cost savings
- High/Low/OFF switch
- Daisy chain power to multiple lights
- Metal housing, shatterproof window
- Easy installation with snap clips, or a choice of magnetic or angle brackets



Cordsets for DC Models

	4-pin Euro-Style	MQDC-415 5 m (15')
		MQDC-415RA 5 m (15')
	4-pin Euro-Style QD Double-Ended Straight/Straight or Straight/Right-angle	MQDEC-403SS 1 m (3')
		MQDEC-403RS 1 m (3')
	4-pin Euro-Style QD Splitter	Branches Trunk
		0.3 m 0.3 m
		CSB-M1241M1241

Cordsets for AC Models

	Double-Ended NEMA 5-15 grounded (IEC Type B)	LQMAC-306B 2 m (6.5')
	Double-Ended For Cascading Straight/Straight	LQMAEC-312SS 3 m (12')



PTL110

Scalable, Versatile Pick-to-Light Solution



- Achieve fast picking speeds in large scale systems with PICK-IQ™ serial communication
- Optimize application performance with options including optical sensor, touch button and display
- Reduce system costs with simple mounting and direct device connection

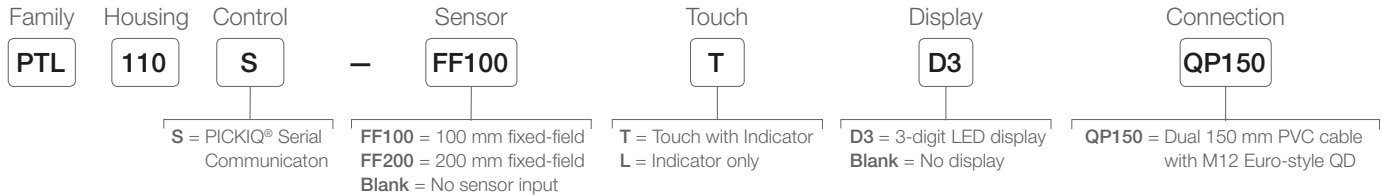

LMBPTL110F

For slotted extrusion and flat rail mounting



LMBPTL110A45



LMBPTL110C

For 28 mm tubular racking



4-pin Euro-Style



5-Pin M12/Euro-Style Shielded
Straight connector models listed



4-pin Euro-Style QD
Double-Ended
Female Straight/Male Straight



4-pin Euro-Style QD
Double-Ended
Male Straight/Male Straight



4-pin Euro-Style QD
Double-Ended
Female Straight/Female Straight

MQDC-415

5 m (15')

MQDC-415RA

5 m (15')

MQDC-STP-515

5 m (15')

MQDEC-406SS

2 m (6.5')

MQDEC-401SS-MM

0.3 m (1')

MQDEC-401SS-FF

0.3 m (1')



WLB72

Industrial LED Strip Light

- Improve visibility with bright, uniform illumination
- Reduce costs through high-efficacy, low-maintenance design
- Simplify installation and wiring with versatile, reliable hardware

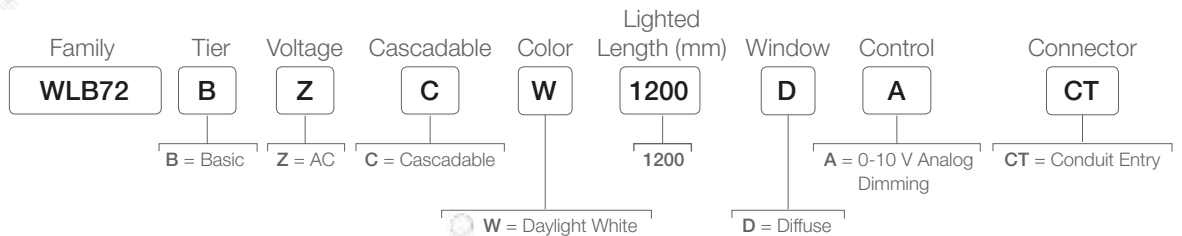

LMBWLB72HK5



LMBWLB72F



LMBWLB72RAS



WLS28-2 Series

LED Light Strip

- Compact, space-saving design
- Rugged, water-resistant IP69K option
- Available in 8 lengths from 145 mm to 1130 mm
- Lensed models, or choice of clear or diffused window
- Cascadable models available for connecting multiple lights end-to-end
- Low power consumption less than 9 watts per foot
- Optional snap clips for easy installation and repositioning

Single-Color

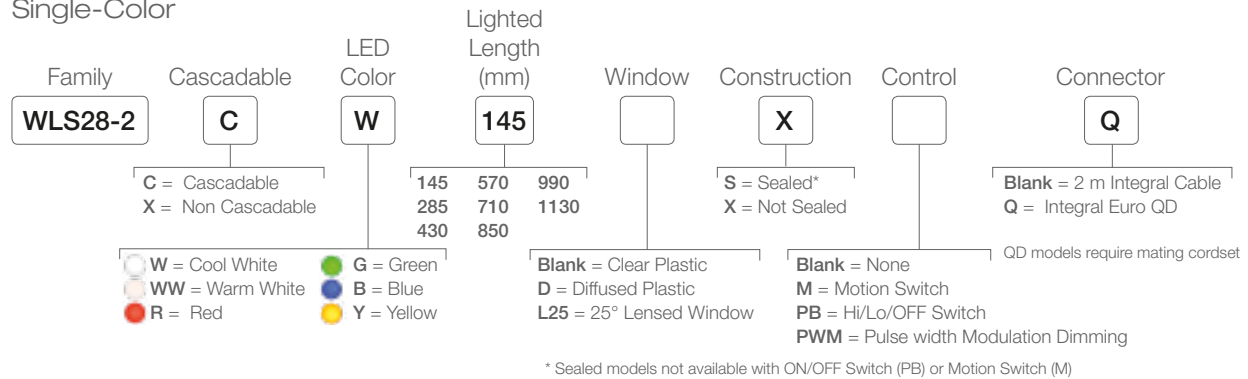

UV Models

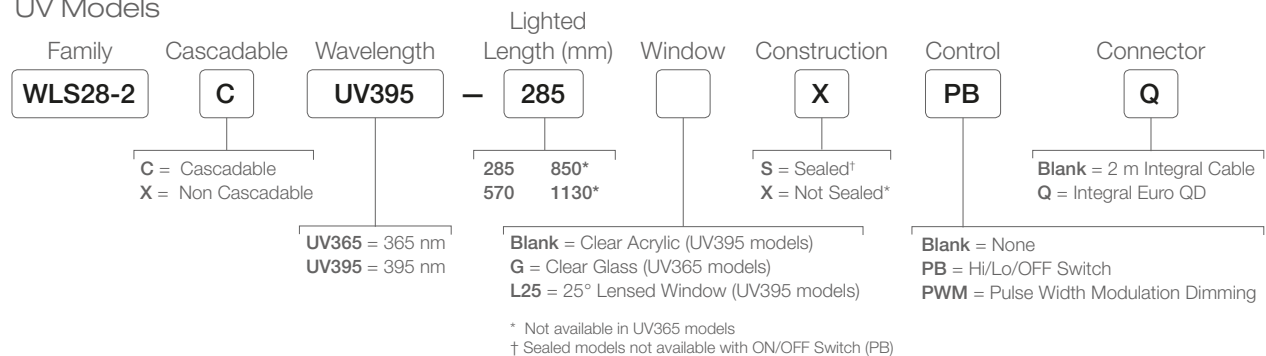

Dual Colors Models

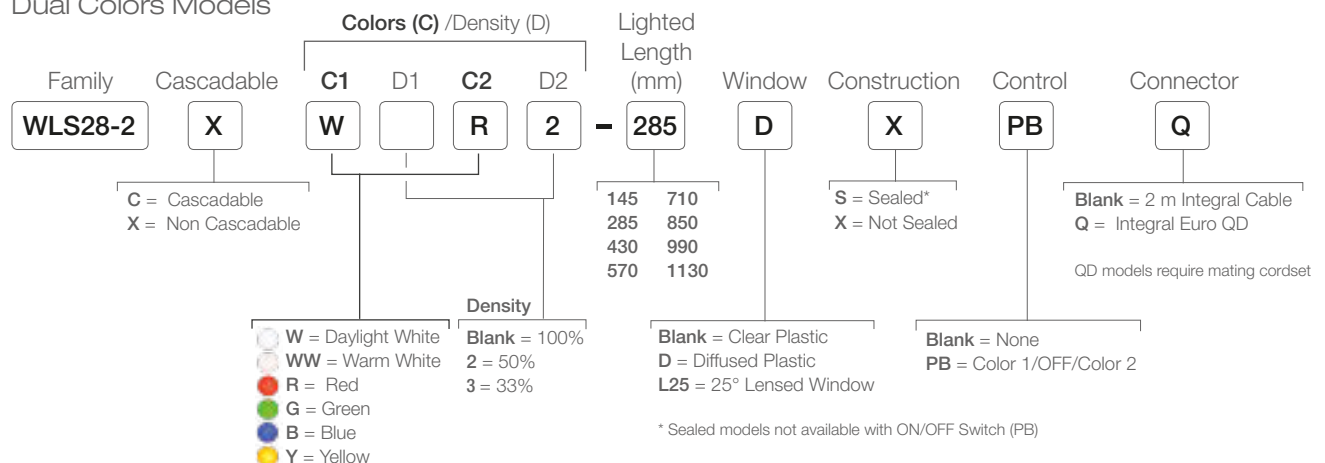

Multicolor with EZ-STATUS® Models

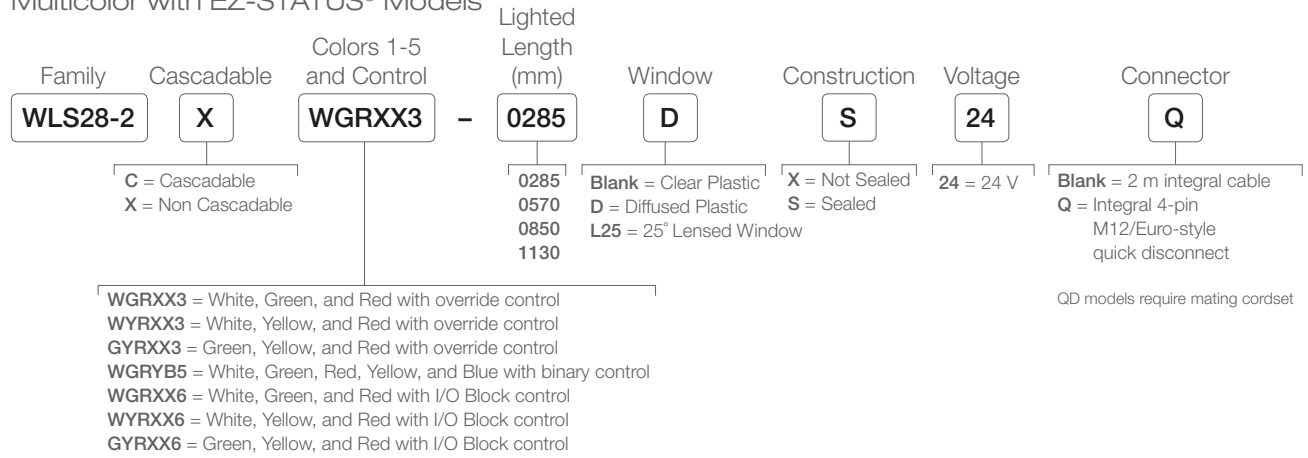

Compact, space-saving design available in eight lengths from 145 to 1130 mm

Lensed models or choice of clear or diffuse window

Optional switch for local intensity or color control IP69K sealed model options available

Top Mount



SMBWLS28RA
(included with light)

Side Mount



SMBWLS28SM

Magnetic Mount



SMBWLSMAG
SMBWLSMAGR
Protective cover for magnet sold separately

Snap Mount



SMBWLS28SP



WLS28-2MQ
In-Line Motion Detection Switch with M12 Connectors



WLS28-2PBQ
In-Line Switch with M12 Connectors



PSD-24-4 Class 2 Power Supply
Input: 90-264 V ac 1.5A
Output: 24 V dc 3.9A
2 m (6.5') 4-Pin Euro Connector



4-pin Euro-Style

4-pin Euro-Style QD Double-Ended Straight/Straight

MQDC-415
5 m (15')
MQDC-415RA
5 m (15')
MQDEC-403SS
1 m (3')



LASER MARKING AVAILABLE

TL50 Tower Lights

Preconfigured Tower Lights

- Exceptionally bright, highly visible from a distance
- Install quickly and easily with no assembly required
- Clearly evident on/off status
- Versatile mounting options
- Compact, sleek, rugged design with IP67 models available
- Audible alert: continuous, pulsed and staccato models available



Audible
max. intensity 92 db
@ 1 meter (typical)



Sealed
max. intensity 94 db
@ 1 meter (typical)



Sealed Omni-Directional
max. intensity 99 db
@ 1 meter (typical)

Standard and High-Brightness

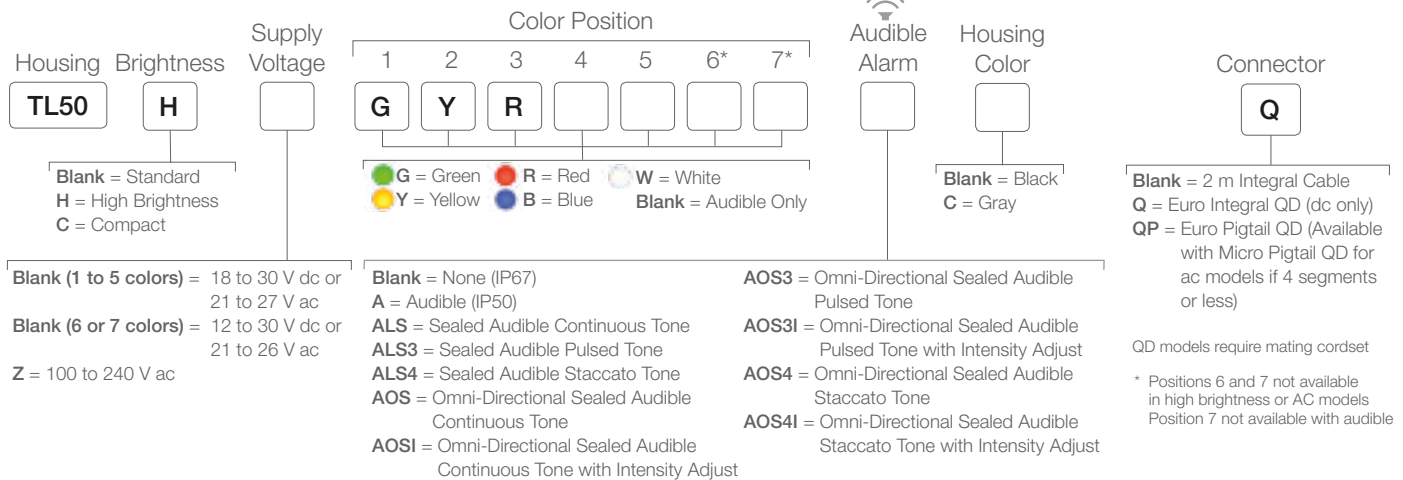

SMB30A



SMB30MM



SMBAMS30P



SMB30RAVK



3 Segments/
4-Pin Euro-Style
for use with DC models

MQDC-415
5 m (15')
MQDC-415RA
5 m (15')



4 Segments/
5-Pin Euro Style
for use with DC models

MQDC1-515
5 m (15')
MQDC1-515RA
5 m (15')



5+ Segments/
8-Pin Euro Style
for use with DC models

MQDC2S-815
5 m (15')
MQDC2S-815RA
5 m (15')



3 Light Segments/
4-Pin Micro-Style
for use with AC models

MQAC-415
5 m (15')
MQAC-415RA
5 m (15')

4 Lights/5-Pin
Micro-Style
for use with AC models

MQDAC2-515
5 m (15')
MQDAC2-515RA
5 m (15')



TL50 Pro Tower Lights

Programmable Tower Lights

- Up to ten segments (depending on model) for advanced status signaling and high-resolution process details
- Full control of color, flashing, rotation and intensity settings
- Advanced animations like level, timer, counter and action mode provide dynamic visual response
- Parameter and process data options on IO-Link models enable fast and complete control of functionality
- Discrete models are programmable using Banner's Pro Editor software and Pro Converter Cable

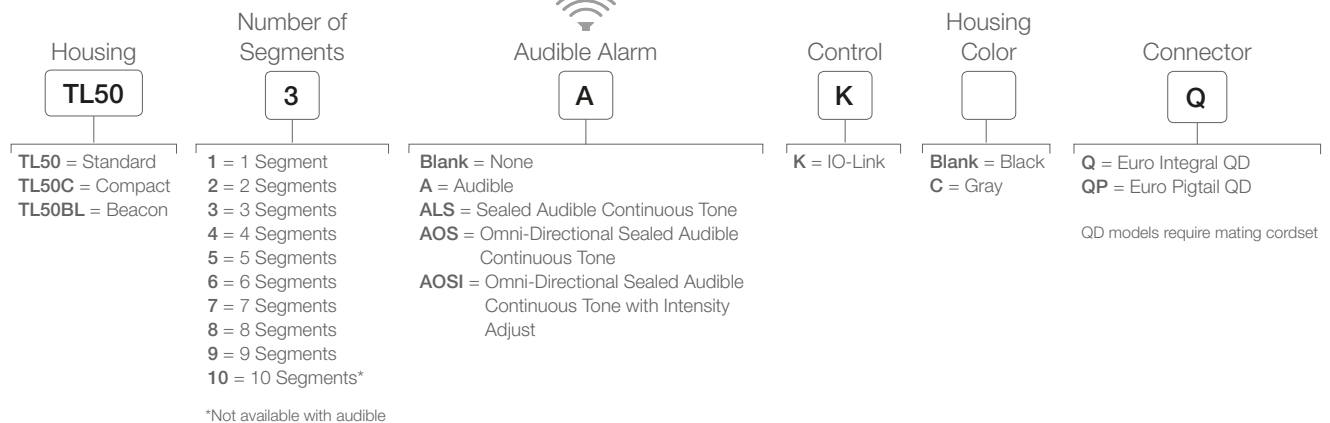
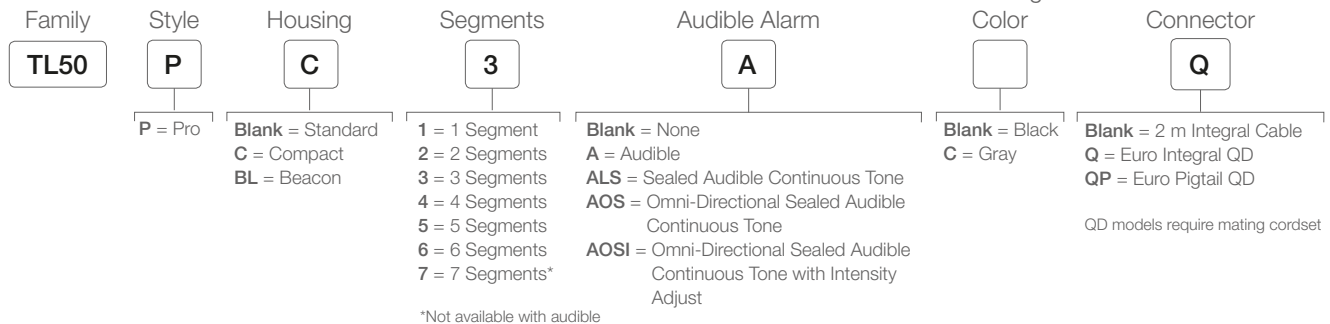

PRO-KIT-ACC Includes:

- MQDC-506-USB
Pro Converter Cable
- CSB-M1251FM1251M
Splitter
- PSW-24-1
Power Supply

- ACC-PRO-CABLE5
Mating accessory for cabled and terminal models
- MQDC-801-5M-PRO
5-pin to 8-pin double-ended cordset



LASER
MARKING
AVAILABLE

TL70 Tower Lights

Modular Tower Lights

- Light segments have user-selectable solid ON or flashing
- Up to six light segments (six color options) or five segments plus an audible in one device
- Rugged, water-resistant IP65 housing with UV stabilized material
- Bright, uniform indicator segments appear gray when off to eliminate false indication from ambient light

Preassembled DC

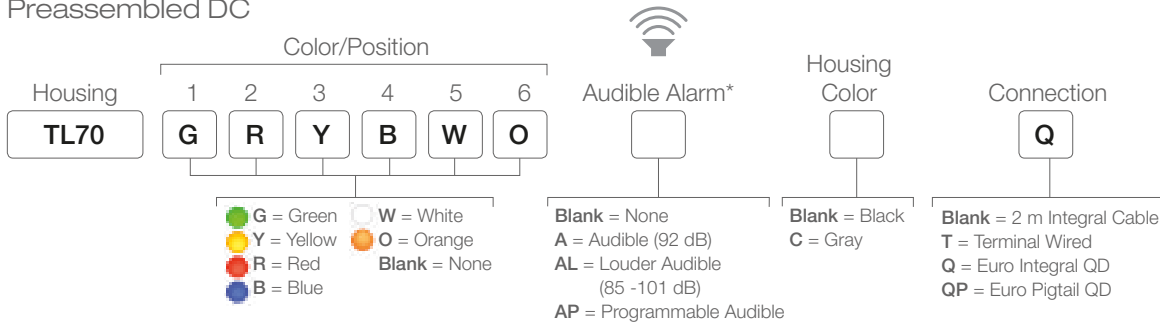

Preassembled AC

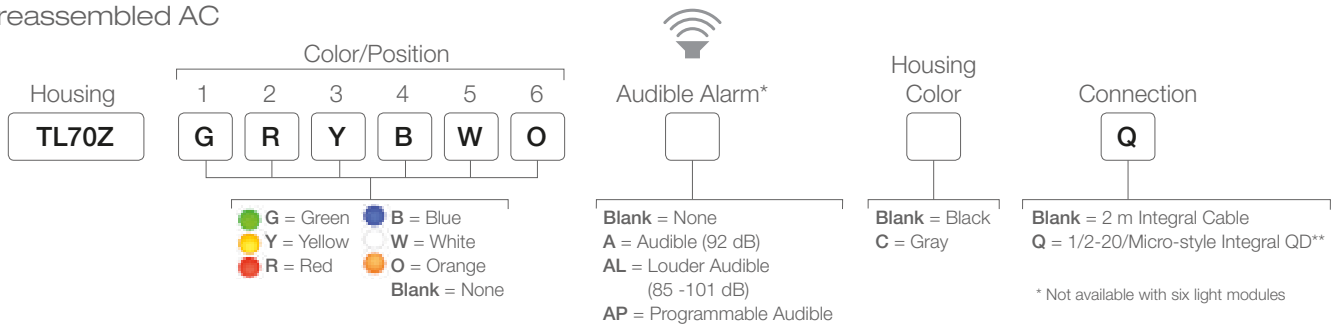

Preassembled Wireless

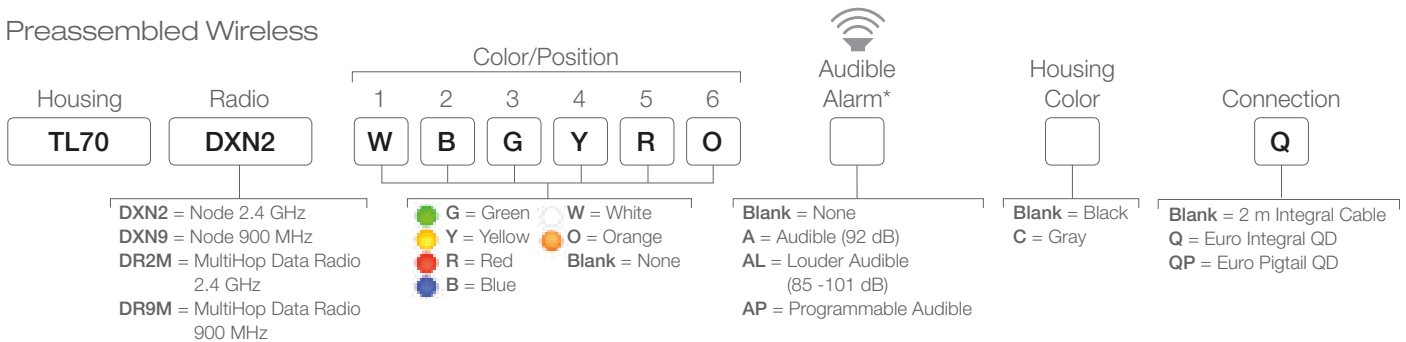

Requires Gateway or master radio of the same frequency



K50 and K30 Pro

Domed and Compact Indicators

- Simplified ordering and design
- Reliable performance in harsh environments
- Improved production efficiency
- Compact models for low profile applications
- Full flexibility of colors and animations with Pro Editor software or IO-Link®

K50 Pro

Example Model Number: K50L2RGB7Q

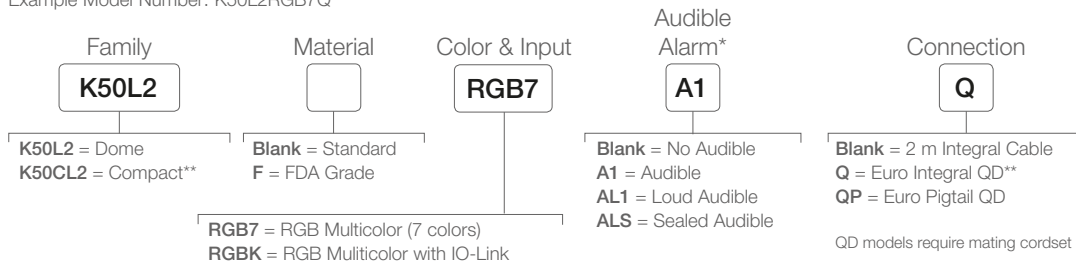

* Audible models not available in FDA-grade material or compact

** Compact and integral QD models not available in FDA-grade material

K30 Pro

Example Model Number: K30L2RGB7Q

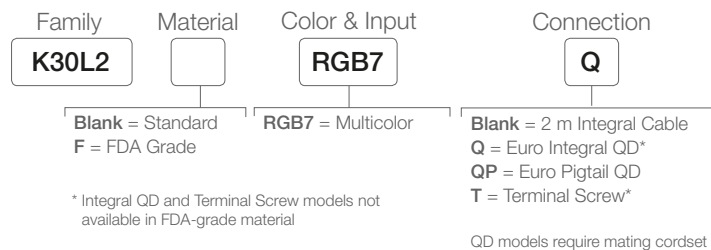

SMB30FA



SMB22FVK



SMB30SC



SMB22A



PRO-KIT-ACC Includes:

MQDC-506-USB
Pro Converter Cable
CSBM1251FM1251M
Splitter
PSW-24-1
Power Supply

ACC-PRO-CABLE5
Mating accessory for
cabled and terminal
models
MQDC-801-5M-PRO
5-pin to 8-pin
double-ended cordset



4-Pin Euro QD



5-Pin Euro QD



5-Pin M12/ Euro QD
Washdown (IP69K)
Straight connector

MQDEC-415
5 m (15')
MQDEC-415RA
5 m (15')

MQDC1-515
5 m (15')
MQDC1-515RA
5 m (15')

MQDC-WDSS-0515
5 m (15')



S22 Touch Series

Flush Touch Button

- Large, bright illuminated area for clear visibility of input and touch status
- Flush mount design sits tight against panel, machine and bracket surfaces
- Independent color control or preconfigured models to suit your indication needs
- Momentary versions remain activated as long as touch is present, while latching versions toggle between activated and not activated states on successive touches
- Excellent immunity to false triggering by water spray, detergents, oils, and other foreign materials
- Rugged, water-resistant IP69K design for washdown environments
- Ergonomically designed to eliminate hand, wrist and arm stresses, requiring no physical pressure to operate and can be actuated with bare hands or work gloves

Multipurpose Independent Control

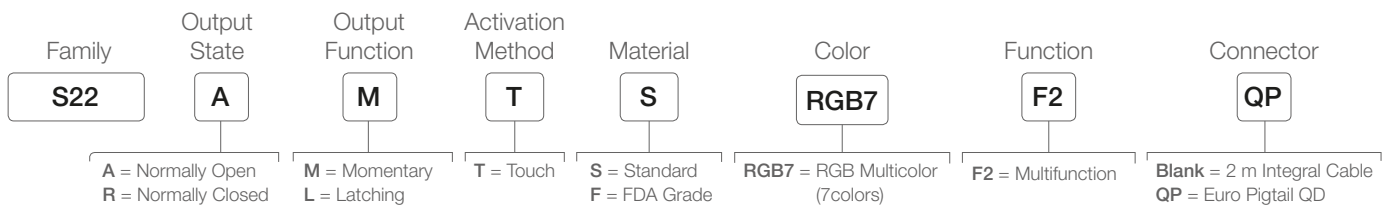

Illuminated Button Control

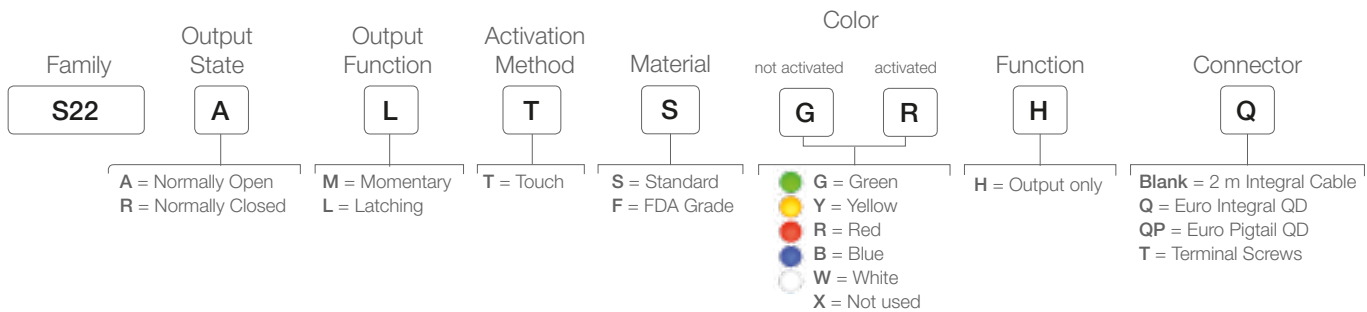

SMB22A



SMB22FVK



SMBAMS22P



SMB22RAVK



5-pin Euro QD

MQDC1-515
5 m (15')
MQDC1-515RA
5 m (15')



5-pin M12 Euro-Style Washdown
Straight connector
models only

MQDC-WDSS-0515
5 m (15')



VE Series

Versatile, Easy-To-Use Smart Cameras

- Available in 5 MP (2592 x 2048 pixels), 2MP (1600 x 1200 pixels), 1.3MP (1280 x 1024 pixels), and WVGA (752 x 480 pixels) models, all with the same powerful inspection capabilities
- Runtime editing capability reduces costly downtime and the software emulator allows for offline building and troubleshooting of applications
- Factory communications (EtherNet/IP™, Modbus/TCP, PROFINET® and RS-232 Serial) for integration on the manufacturing floor
- Two-line, eight-character onboard display provides inspection information and focus number and makes it easy to update sensor settings, facilitating fast product changeover
- Robust metal housing with optional lens covers with or without LED lighting to achieve IP67 rating for use in harsh environments with heat, vibration, or moisture

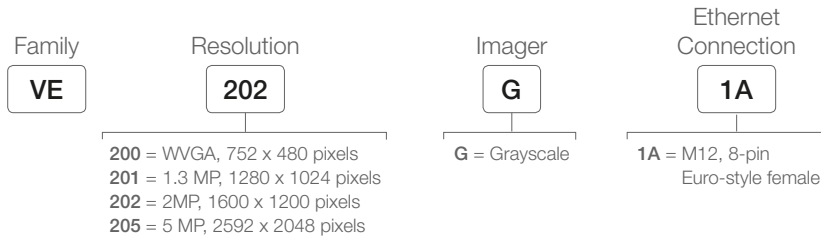

SMBVERA



SMBVEMP
Mounting Plate



12-pin Euro with Shield

RJ45 to Ethernet 8-pin M12 Euro (Cat5e shielded)

MQDC2S-1215
MQDC2S-1215RA
5 m (15')

STP-M12-815
5 m (15')



ABR Series

Imager-Based Barcode Readers

- Powerful decoding capability to read even difficult 1D and 2D codes, including DPM and low contrast codes
- Compact metal housing for industrial environments
- Quick configuration with on-board push buttons or a PC using Barcode Manager to solve the most difficult barcode reading applications
- Integrated LED lighting and easy focus adjustment in one package for maximum application flexibility
- Versatile lens options are available to simplify setup and configuration, including autofocus (ABR 7000) which easily adapts to changes in reading distance
- Factory communication options include Ethernet, serial and USB for integration on the manufacturing floor
- Embedded web server interface for monitoring images and statistics over any network

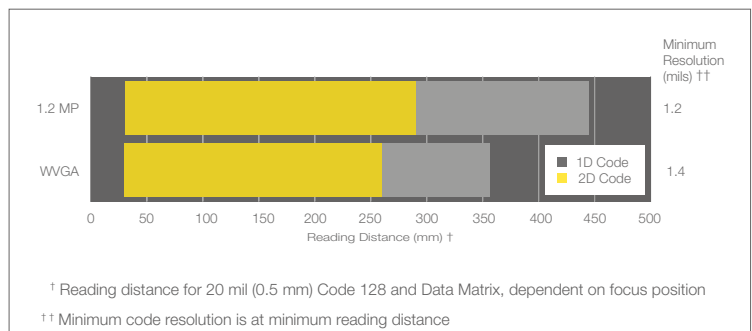
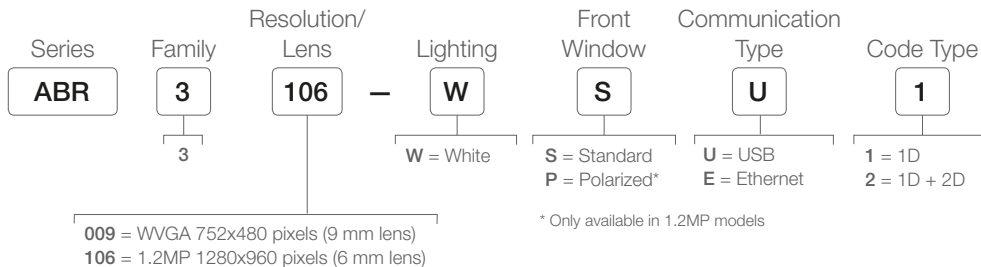
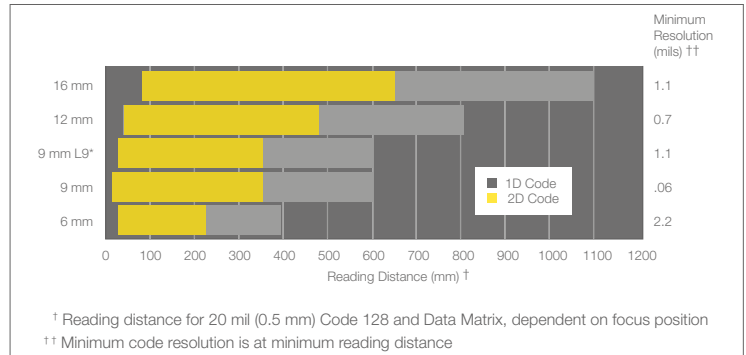
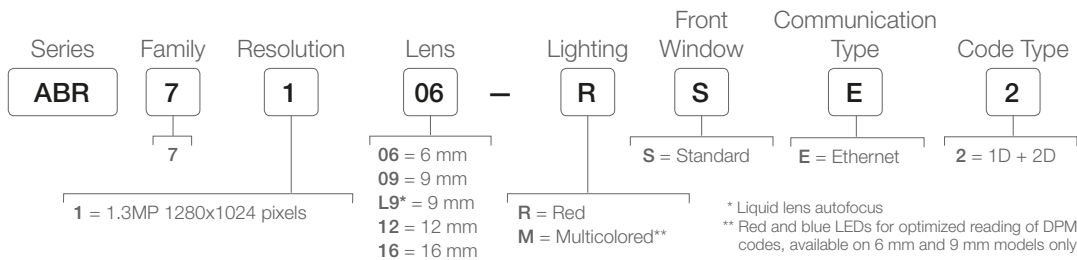

For Use with ABR Ethernet Models



17-pin M12 female shielded (for power, serial and IO)

MQDC2S-1715
5 m (15')

4-pin M12 D-code to RJ45 Ethernet for Ethernet Communication

STP-M12D-415
5 m (15')

Connection Box



TCNM-ACBB1

For Use with ABR USB Models

Power and USB Communication only



17-pin M12 female to USB

MQDEC-1703SS-USB

OR

Power, USB Communication, IO and Serial Communication



17-pin M12 female shielded (for power, serial and IO)

MQDC2S-1715
5 m (15')



Splitter cable. 17-pin M12 female trunk with one 17-pin M12 male branch and one USB branch

CSB-M121701USB02M121702

For Use with TCNM-ACBB1 Connection Box

17-pin M12 female to DB25 (replaces MQDC2S-17xx)

MQDEC-1703SS-DB25
0.9 m (3')

17-pin female to 17-pin male shielded (optional extension cable)

MQDEC-1715SS
5 m (15')



Integrated Touchscreen shown

iVu BCR Barcode Reader

Imager-Based Barcode Readers

- Program through an integrated touch screen, remote touch screen or PC interface
- Reads a variety of 1D and 2D barcodes including DataMatrix (ECC 200), Linear Bar Codes, Code 128, Code 39, Codabar, Interleaved 2 of 5, EAN 13, EAN 8, UPC-E, POSTNET, IMB, and Pharmacode
- Ethernet (EtherNet/IP™, Modbus/TCP, and PROFINET®) and Serial RS-232 communications
- Read multiple barcodes in any orientation with one device
- Rugged IP67 housing for factory environments
- Available with a variety of lens and integrated light options – red, blue, green, white, UV or infrared

Series	Touch Screen	Sensor Type	Ring Light Color	Lens (mm)
IVU2P	T	B	R	04
	T = Integrated R = Remote*	B = Barcode	R = Red B = Blue G = Green W = White I = Infrared	6 = UV365 9 = UV395 XC = C-mount X = No Ring Light
				04 = 4.3 06 = 6 08 = 8 12 = 12 16 = 16 25 = 25 Blank = No lens (only C-Mount)

* Remote display or PC is required for set up and viewing of Remote Touch Screen sensors

Accessories shown on page 66



iVu Vision Sensors

Color and Grayscale Vision Sensors

- The iVu and iVu Color Vision Sensors are used to monitor parts for type, size, orientation, shape, location, and color or color variations.
- Configure in minutes using Vision Manager PC software, onboard touchscreen display or using remote touchscreen to access to hard to reach places
- All-in-one solution with camera, controller, lens, and light included in one package
- Inspect multiple features with a wide variety of grayscale or color tools
- Compact, rugged, IP67 housing available with a variety of integrated ring lights including red, blue, green, white, infrared or UV
- Interchangeable lenses, including C-mount, for maximum application flexibility
- Factory communications (EtherNet/IP™, Modbus/TCP, PROFINET®, PCCC and Serial RS-232) for integration on the manufacturing floor
- Ability to change parameters on the fly with full runtime editing to reduce costly downtime

Series	Touch Screen	Sensor Type	Ring Light Color	Lens (mm)
IVU2P	T	G	R	04
	T = Integrated R = Remote*	C = Color† G = Grayscale	R = Red B = Blue G = Green W = White I = Infrared 6 = UV365 9 = UV395 XC = C-mount** X = No Ring Light	04 = 4.3 06 = 6 08 = 8 12 = 12 16 = 16 25 = 25 Blank = No lens (only C-Mount)

* Remote display or PC is required for set up and viewing of Remote Touch Screen sensors

** Requires C-mount lens

† Color sensor only available in white, C-mount or no ring light



RDM35 Remote Touch Screen (sold separately)

Sensors with Remote Touch Screen



SMBIVURAL



SMBIVURAR



SMBIVUU



SMBRDM35
Docking station for machine mountable remote display



Power (Required)

12-Pin M12/Euro with Shield



Ethernet (Required for Ethernet communications)

RJ45 to 4-Pin Pico QD



USB

Used to update firmware and access sensor files



Machine Mountable Remote Display (Required for use of RDM35 remote display)

Double-ended M12/ 8-pin Euro

MQDC2S-1215

5 m (15')

MQDC2S-1215RA

5 m (15')

IVUC-E-415

5 m (15')

PSG-4M-403-USB

0.9 m (3')

IVURDM-QD-815

5 m (15')

IVURDM-QD-815RA

5 m (15')



DXM Wireless Controller

Industrial Wireless Controller

- Enables end-to-end IIoT solutions, connecting Banner sensors to Banner's Connected Data Solutions (CDS) cloud platform
- Integrates Banner's ISM radio, cellular connectivity, and local I/O
- Program the DXM using action rules and ScriptBasic language, which can execute concurrently
- Log data on the Micro SD card
- Automation protocols include Modbus RTU, Modbus/TCP, and EtherNet/IP for communications with PLC's, HMI's, or other local hosts
- Interactive programmable user interface with LCD and LED indicators
- Industry standard RS-485, Ethernet, and USB communication ports
- Easily interfaces with Banner CDS and other cloud service providers

Controller Models*

Models	Description	Frequency
DXM700-B1R1	DXM700 Controller with Performance Series Gateway	900 MHz
DXM700-B1R2	DXM700 Controller with MultiHop Modbus Data Radio	900 MHz
DXM700-B1R3	DXM700 Controller with Performance Series Gateway	2.4 GHz
DXM700-B1R4	DXM700 Controller with MultiHop Modbus Data Radio	2.4 GHz
DXM1000-B1R1	DXM1000 Controller with Performance Series Gateway	900 MHz
DXM1000-B1R2	DXM1000 Controller with MultiHop Modbus Data Radio	900 MHz
DXM1000-B1R3	DXM1000 Controller with Performance Series Gateway	2.4 GHz
DXM1000-B1R4	DXM1000 Controller with MultiHop Modbus Data Radio	2.4 GHz

Connected Data Solutions (CDS) Software Packages



Models	Description
806252	Starter Package 1,000 Data Points per hour Total Storage: 2 million Data Points
806253	Standard Package 4,000 Data Points per hour Total Storage: 20 million Data Points
806254	Premium Package 12,000 Data Points per hour Total Storage: 100 million Data Points



PSD-24-4
DC power supply – desktop style, 24 V dc 4A, Euro 4-pin connector



PSDINP-24-13
DC power supply DIN rail mount, 24 - 28 V dc, 1.3A



MQDMC-401
Euro-style male quick disconnect cable, 4-Pin straight connector



BWA-AH12106
enclosure



SX1-LTE-001
Cellular Data Modem Verizon 4G LTE Cat. 1



SX1-GSM-001
Cellular Data Modem Worldwide HSPA 3G with 2G GSM fallback



Q45 Nodes

for Predictive Maintenance

- To save on installation time, Q45 1-wire serial nodes are pre-configured to work with Banner 1-wire serial sensors. The compact size, integrated lithium batteries, and a variety of compatible sensors make remote monitoring easy.
- The Q45VTP is designed to pair with the QM30VT1 Vibration and Temperature sensor. Vibration characteristics and sample intervals can be set using DIP switches.
- The Q45TH connects directly to the M12FTH4Q temperature and humidity sensor. Sample rates can be set using DIP switches.
- The Q45U is a universal 1-wire serial node that reads any Banner 1-wire serial sensor and determines an efficient power setting.

Select Your Node

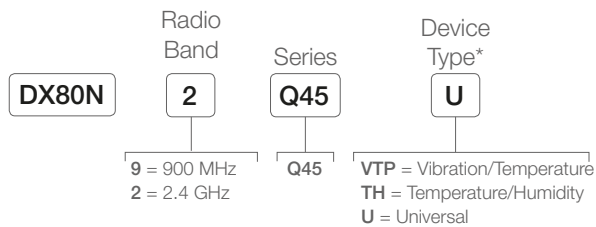

* Sensor units must be ordered separately

Select Your Sensor



Q45

All-in-One Sensors

- Vibration and Temperature or Tank Level sensor and node in one compact package
- Uses a 1-wire serial interface
- Easy-to-order
- Easy-to-deploy
- DIP switch configurable for vibration characteristics and sample intervals
- Dual-axis vibration sensing

Vibration: Sensor and Node

Models	Frequency	Description
DX80N9Q45VA	900 MHz	All-in-one Vibration and Temperature sensor
DX80N2Q45VA	2.4 GHz	All-in-one Vibration and Temperature sensor sensor

Ultrasonic: Sensor and Node

Models	Range	Description
DX80N9Q45UAC	900 MHz	Q45 Node with Integrated Ultrasonic Sensor
DX80N2Q45UAC	2.4 GHz	Q45 Node with Integrated Ultrasonic Sensor



QM30VT Series

Vibration and Temperature Sensor

- Avoid machine failures and delays by detecting problems early
- Provides high accuracy vibration and temperature measurements
- Dual-axis vibration detection up to 4 KHz bandwidth
- Manufactured with a sealed aluminum housing
- Reduces labor costs by obviating manual checks and eliminating error

Models	Description
QM30VT1	Vibration and temperature sensor with 1-wire serial interface; 3 m QD cable
QM30VT2	Vibration and temperature sensor that functions as a modbus slave device via RS-485; 3 m QD cable
QM30VT2-SS-9M	Vibration and temperature sensor with stainless steel housing that functions as a modbus slave device via RS-485; 9 m cable with flying leads



BWA-BK-013



BWA-BK-012



5-pin Double Ended
M12/Euro-Style
with Shield

DEE2R-53D
1 m (3')



K50U Ultrasonic Sensor

Wireless Level and Tank Monitoring

- Provides a distance measurement from the target to the sensor
- Monitor wirelessly to avoid long cable runs
- Built-in temperature compensation for reliable measurement
- Threaded housing for easy installation

Models	Description
K50UX1ARA	Ultrasonic sensor with 1-wire serial interface; 1 m sensing range
K50UX1CRA	Ultrasonic sensor with 1-wire serial interface; 3 m sensing range
K50UX2ARA	Ultrasonic sensor that functions as a modbus slave device via RS-485; 1 m sensing range
K50UX2CRA	Ultrasonic sensor that functions as a modbus slave device via RS-485; 3 m sensing range



BWA-BK-006
Mounts both the K50U
Ultrasonic sensor and
a Wireless Q45 Node



5-pin Double Ended
M12/Euro-Style
with Shield

DEE2R-53D
1 m (3')



Pressure Sensor Node

All-in-One Performance Series Node

- Combines a media isolated pressure sensor, a Performance Series wireless node, and a battery power supply
- Compact, one-piece design simplifies installation and eliminates the need for ordering multiple components
- Integrates easily in applications where infrastructure, movement, or mobility make wired solutions impractical, ineffective, or cost-prohibitive
- Field-proven, Sure Cross wireless architecture ensures secure, reliable communication between devices

Models	Description
DX80N9X1W-PS50G	0-50 PSI GAUGE Pressure Sensor in the housing port pre-wired to the Node
DX80N9X1W-PS50G1	0-50 PSI GAUGE Pressure Sensor in the housing port 1 meter cable pre-wired to the Node
DX80N9X1W-PS150G	0-150 PSI GAUGE Pressure Sensor in the housing port pre-wired to the Node
DX80N9X1W-PS150G1	0-150 PSI GAUGE Pressure Sensor in the housing port 1 meter cable pre-wired to the Node
DX80N9X1W-PS500S	0-500 PSI SEALED GAUGE Pressure Sensor in the housing port pre-wired to the Node
DX80N9X1W-PS500S1	0-500 PSI GAUGE SEALED Pressure Sensor in the housing port 1 meter cable pre-wired to the Node



Condition Monitoring Node

Vibration, Temperature, and Current

- Performance Node with a Euro-style connector for use with a Banner VT1 Vibration and Temperature sensor (sold separately) and one-meter twisted pair cable for use with a current transformer
- 20 A and 150 A split core current transformers included
- DIP switch configurable
- Compatible with the Vibrations Solutions Kit
- Improved internal antenna for extended wireless range
- 6+ year battery life

Models	Frequency	Description
DX80N9X1W-CM1L	900 MHz	Pre-wired Euro-style connector for use with any Banner 1-Wire Serial Vibration Sensor (sold separately). Pre-wired one-meter twisted pair cable reports true RMS current (20 A and 150 A current transformers included with Node).
DX80N2X1W-CM1L	2.4 GHz	

Архангельск (8182)63-90-72
Астана (7172)727-132
Астрахань (8512)99-46-04
Барнаул (3852)73-04-60
Белгород (4722)40-23-64
Брянск (4832)59-03-52
Владивосток (423)249-28-31
Волгоград (844)278-03-48
Вологда (8172)26-41-59
Воронеж (473)204-51-73
Екатеринбург (343)384-55-89
Иваново (4932)77-34-06

Ижевск (3412)26-03-58
Иркутск (395)279-98-46
Казань (843)206-01-48
Калининград (4012)72-03-81
Калуга (4842)92-23-67
Кемерово (3842)65-04-62
Киров (8332)68-02-04
Краснодар (861)203-40-90
Красноярск (391)204-63-61
Курск (4712)77-13-04
Липецк (4742)52-20-81
Киргизия (996)312-96-26-47

Магнитогорск (3519)55-03-13
Москва (495)268-04-70
Мурманск (8152)59-64-93
Набережные Челны (8552)20-53-41
Нижегород (831)429-08-12
Новокузнецк (3843)20-46-81
Новосибирск (383)227-86-73
Омск (3812)21-46-40
Орел (4862)44-53-42
Оренбург (3532)37-68-04
Пенза (8412)22-31-16
Казахстан (772)734-952-31

Пермь (342)205-81-47
Ростов-на-Дону (863)308-18-15
Рязань (4912)46-61-64
Самара (846)206-03-16
Санкт-Петербург (812)309-46-40
Саратов (845)249-38-78
Севастополь (8692)22-31-93
Симферополь (3652)67-13-56
Смоленск (4812)29-41-54
Сочи (862)225-72-31
Ставрополь (8652)20-65-13
Таджикистан (992)427-82-92-69

Сургут (3462)77-98-35
Тверь (4822)63-31-35
Томск (3822)98-41-53
Тула (4872)74-02-29
Тюмень (3452)66-21-18
Ульяновск (8422)24-23-59
Уфа (347)229-48-12
Хабаровск (4212)92-98-04
Челябинск (351)202-03-61
Череповец (8202)49-02-64
Ярославль (4852)69-52-93

<https://banner.nt-rt.ru/> || brr@nt-rt.ru