

Архангельск (8182)63-90-72
Астана (7172)727-132
Астрахань (8512)99-46-04
Барнаул (3852)73-04-60
Белгород (4722)40-23-64
Брянск (4832)59-03-52
Владивосток (423)249-28-31
Волгоград (844)278-03-48
Вологда (8172)26-41-59
Воронеж (473)204-51-73
Екатеринбург (343)384-55-89
Иваново (4932)77-34-06

Ижевск (3412)26-03-58
Иркутск (395)279-98-46
Казань (843)206-01-48
Калининград (4012)72-03-81
Калуга (4842)92-23-67
Кемерово (3842)65-04-62
Киров (8332)68-02-04
Краснодар (861)203-40-90
Красноярск (391)204-63-61
Курск (4712)77-13-04
Липецк (4742)52-20-81
Киргизия (996)312-96-26-47

Магнитогорск (3519)55-03-13
Москва (495)268-04-70
Мурманск (8152)59-64-93
Набережные Челны (8552)20-53-41
Нижний Новгород (831)429-08-12
Новокузнецк (3843)20-46-81
Новосибирск (383)227-86-73
Омск (3812)21-46-40
Орел (4862)44-53-42
Оренбург (3532)37-68-04
Пенза (8412)22-31-16
Казахстан (772)734-952-31

Пермь (342)205-81-47
Ростов-на-Дону (863)308-18-15
Рязань (4912)46-61-64
Самара (846)206-03-16
Санкт-Петербург (812)309-46-40
Саратов (845)249-38-78
Севастополь (8692)22-31-93
Симферополь (3652)67-13-56
Смоленск (4812)29-41-54
Сочи (862)225-72-31
Ставрополь (8652)20-65-13
Таджикистан (992)427-82-92-69

Сургут (3462)77-98-35
Тверь (4822)63-31-35
Томск (3822)98-41-53
Тула (4872)74-02-29
Тюмень (3452)66-21-18
Ульяновск (8422)24-23-59
Уфа (347)229-48-12
Хабаровск (4212)92-98-04
Челябинск (351)202-03-61
Череповец (8202)49-02-64
Ярославль (4852)69-52-93

<https://banner.nt-rt.ru/> || brr@nt-rt.ru

Laser Sensor Solutions

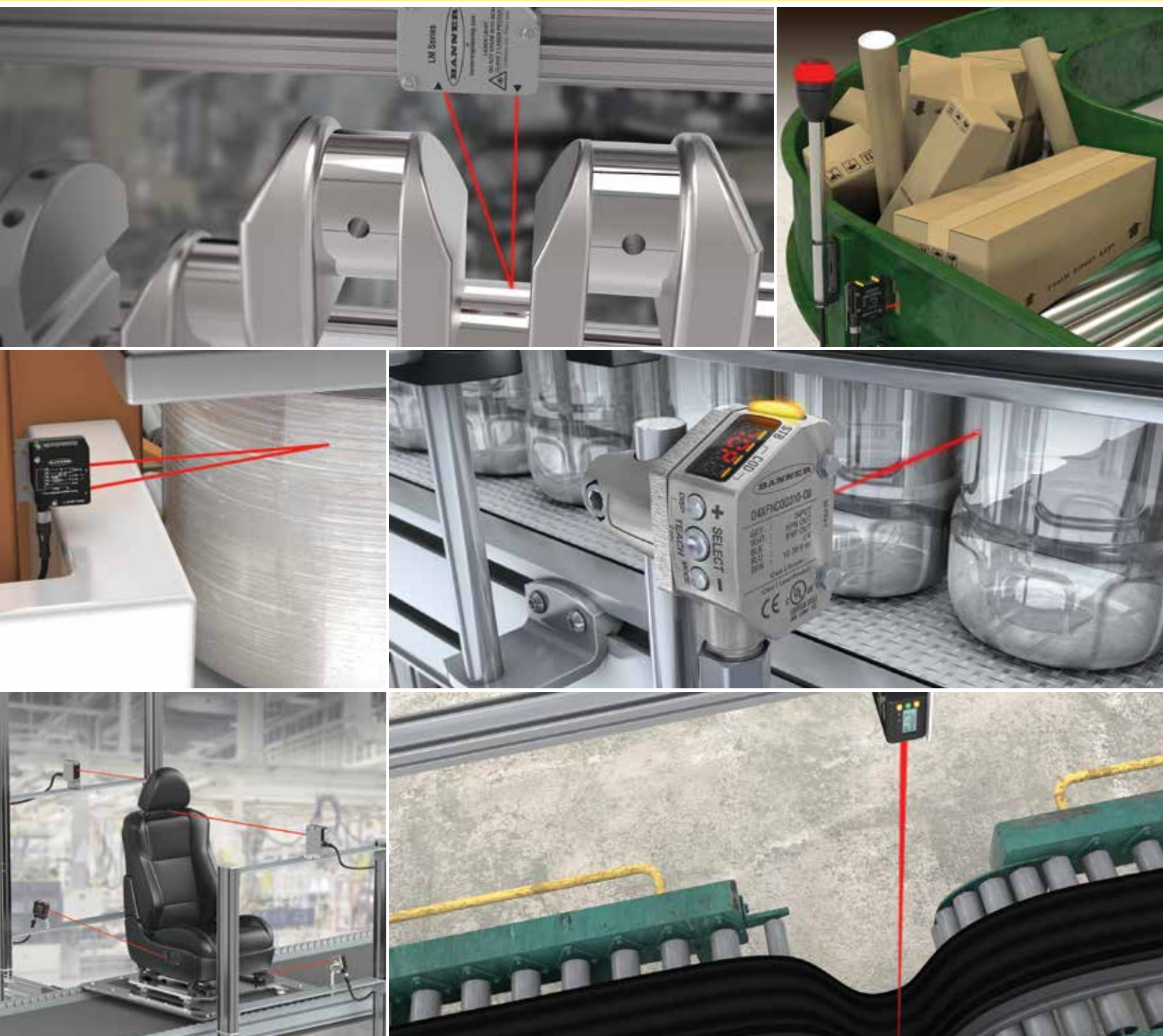

Banner Laser Distant Measurement Sensors

Laser measurement sensors from Banner Engineering solve a wide variety of Discrete, Analog, and IO-Link sensing applications. Our portfolio of laser sensors includes powerful problem solving, high precision, and long-range sensors.

Laser sensors have traditionally been used for their extended range, visible beam, small spot, and precise detection capabilities. These benefits have often been outweighed by their higher costs compared with other technologies. In recent years, pricing on components has been reduced and the technology has advanced so that the benefits of laser sensors outweigh the cost differential.

Banner Laser Measurement Sensors have been designed to excel in harsh environments and remove common sensing barriers.



Optimized for the Most Challenging Targets

Automatic Gain Compensation and Highest Excess Gain in Class

- Other sensors can be oversaturated and experience increased error from shiny targets. Banner laser sensors automatically decrease gain to maintain accuracy.

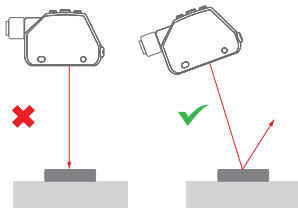
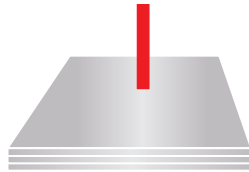

TIP: Change sensor orientation for more reliable detection of shiny objects

- Similarly, dark objects provide a very weak signal, so our laser sensors automatically increase gain to amplify the received signal and reliably measure targets that other sensors can't see.

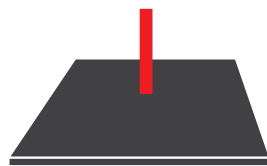

Variety of Beam Spot Sizes for Consistent Detection

- Small spot minimizes measurement variation across color transitions



- Small beam spot is ideal for precise profiling of small features

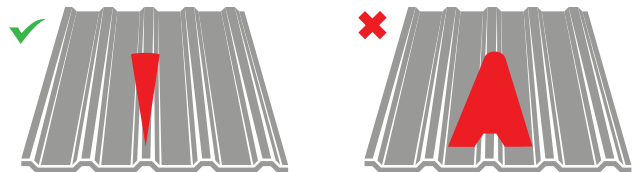

- Large spot provides averaging across rough surfaces for more measurement stability



Measure from 25 millimeters to 24 meters

Triangulation (Short Range/Precise)

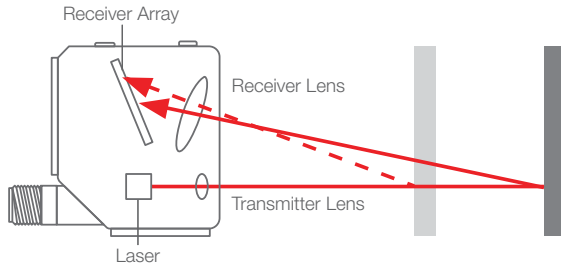

Triangulation sensors determine range by the position of the received light on the receiver array.

Time-of-Flight (Long Range)

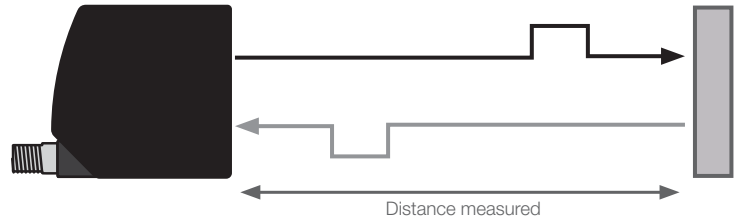

Time of flight sensors derive range from the time it takes light to travel from the sensor to the target and return.

Dual Mode: Distance with Intensity to Detect Any Change

Clear Object Detection

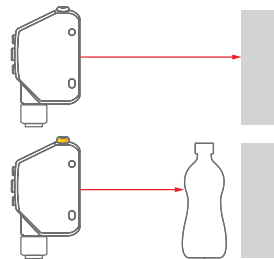

Reliably detects transparent objects without the need of a retro reflector

Meters of Extended Range

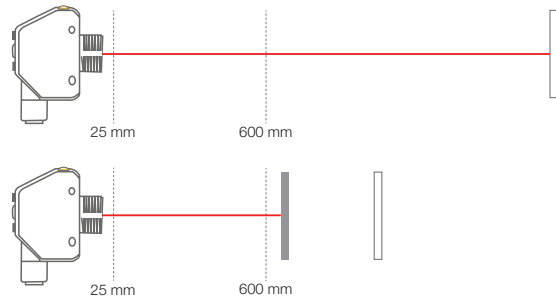

Teach reference to detect changes in contrast, even past the maximum measuring range for presence and absence detection

Error Proofing

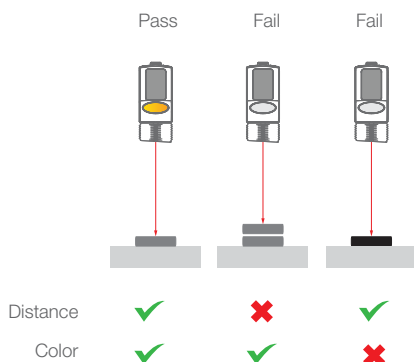

Inspections use distance to verify parts presence and position, and intensity to verify correct color or part orientation

Contrast

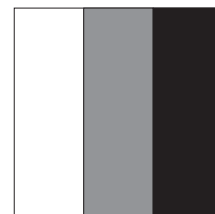

Detects intensity changes due to variation in surface finish, hue, or tone

Choosing a Banner Laser Sensor

Start with the Q4X



If the following are needed:

- Longer range
- More excess gain
- Better precision beyond 100 mm



select Q5X

If the following are needed:

- Better temperature stability
- Higher precision
- Larger Display
- Analog

If the following are needed:

- Longer range
- Better precision beyond 1 m
- Analog

Q4X Applications



Q5X Applications



Rugged Environments

- Food and Beverage Packaging
- Metal Stamping
- Robotic Welding

Precision Measurements

- Vibratory Feeders
- Automotive Assembly
- Semiconductor Wafer Mapping

Low Contrast Sensing

- Plastic Bottle Jam Detection
- Pharmaceutical Vial Counting
- Vibrant Packaging Sensing

Material Handling

- Jam Detection
- Box, tote, and pallet detection

Packaging

- Shrink wrap detection
- Carton full / empty

Lumber and Construction

- Timber, Plywood, Sheetrock manufacturing
- Steel and asphalt shingle manufacturing

Automotive

- Power train and suspension assembly
- Black plastic/leather/rubber detection
- Dashboards & interior/exterior panels



If the following are needed:

- Best performance
- Best temperature stability
- Highest excess gain
- Smallest spot size
- Smaller housing



LE Applications



LTF Applications

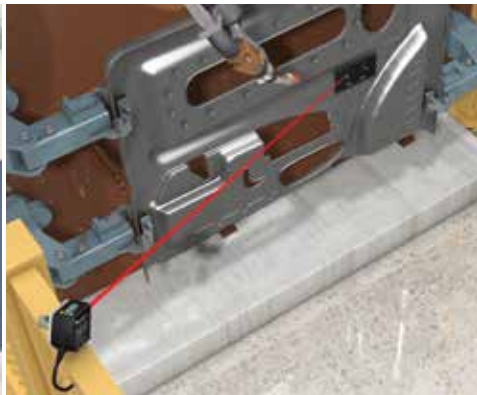

LM Applications

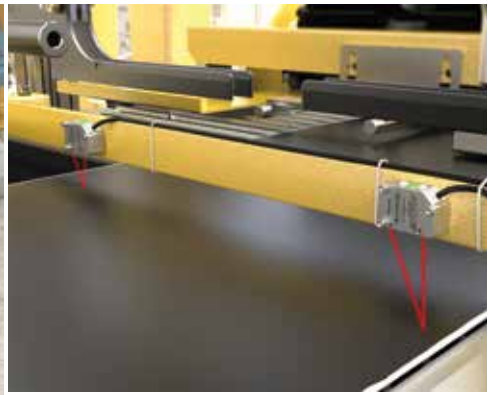

Automotive

- Robot Positioning
- Assembly Inspection
- Tire Gauging

Packaging

- Fill Level
- Box Profiling
- Dancer Arm Position Monitoring

Web Applications

- Loop control
- Roll Diameter
- Web Thickness Gauging

Positioning

- Automated Guided Vehicle
- Automated Warehouse
- Mobile Equipment Collision Avoidance

Measurement

- Hopper Fill Level
- Port Crane Height
- Pallet Height

Process Control

- Roll Diameter
- Loop/tension control
- People Counting

Automotive

- Precise part inspection
- Assembly accuracy checks
- Dimensional control











Electronics & Semiconductor

- Product position control
- PCB warp inspection

Consumer Packaged Goods

- Correct product placement
- Thickness/height measurement

Laser Measurement Sensors Comparison

		Min. to Max. Range (mm)					Analogue	Discrete	IO-Link
		10	100	1000	10000	30000			
 <p>LM Series</p>	 <p>Range: 40 – 150 mm Resolution: 0.002 – 0.004 mm Linearity: $\pm 0.02 - 0.07$ mm Repeatability: $\pm 0.001 - 0.002$ mm MOS*: 0.04 – 0.14 mm Accuracy: $\pm 0.175 - 2$ mm</p>						✓	✓	✓
 <p>Q4X Series</p>	 <p>Range: 25 - 600 mm Resolution: 0.15 – 1.75 mm Linearity: $\pm 0.25 - 25$ mm Repeatability: $\pm 0.2 - 3$ mm MOS*: 0.5 – 10 mm Accuracy: $\pm 0.25 - 25$ mm</p>						✓	✓	✓
 <p>Q5X Series</p>	 <p>Range: 95 mm – 2 m Repeatability: $\pm 0.5 - 10$ mm MOS*: 1 – 35 mm Accuracy: $\pm 3 - 35$ mm</p>							✓	✓
 <p>LE Series</p>	 <p>Range: 100 mm – 1 m Resolution: 0.02 – 1 mm Linearity: $\pm 0.375 - 4.5$ mm Repeatability: $\pm 0.01 - 0.5$ mm MOS*: 0.5 – 8 mm Accuracy: $\pm 0.375 - 10$ mm</p>						✓	✓	✓
 <p>LTF Series</p>	 <p>Range: 50 mm – 24 m Resolution: 0.9 – 12 mm Linearity: $\pm 10 - 25$ mm Repeatability: $\pm 0.45 - 6$ mm MOS*: 1.8 – 24 mm Accuracy: $\pm 10 - 25$ mm</p>						✓	✓	✓

* MOS = Minimum Object Separation

KEY

 Excess Gain

 Rugged

 High Precision

 Long Range

Key Specifications for Analog Applications

Resolution tells you the smallest change in distance a sensor can detect. A resolution of <0.5 mm means that the sensor can detect changes in distance of 0.5 mm. This spec is the same as best case static repeatability, but it is expressed as an absolute number instead of +/-.

The challenge with resolution specs is that they represent a sensor's resolution in "best case" conditions, so they don't provide a complete picture of sensor performance in the real world and sometimes overstate sensor performance. In typical applications, resolution is impacted by target conditions, distance to the target, sensor response speed, and other external factors. For example, glossy objects, speckle, and color transitions are all sources of error for triangulation sensors that can affect resolution.

Linearity refers to how closely a sensor's analog output, plotted against the actual distance, approximates a straight line across the measuring range. When the linearity spec is lower and the sensor is more linear, the measurements across the full range of the sensor are more consistent. Linearity of 0.5 mm means that the greatest variance in measurement across the sensor's range is ± 0.5 mm.

In other words, linearity is the maximum deviation between the interpolated measurement and the actual distance. If a sensor's 4 mA point is set to 100 mm and its 20 mA point is set to 200 mm, we would expect a 12 mA measured value to represent exactly 150 mm, halfway between 100 and 200 mm. In real life, that 12 mA value would actually represent 150 mm +/- the sensor's linearity spec.

Linearity is the most relevant error spec for many applications that require consistent measurements across the range of the sensor.

Key Specifications for Discrete Applications

Repeatability (or reproducibility) refers to how reliably a sensor can repeat the same measurement in the same conditions. Repeatability of 0.5 mm means that multiple measurements of the same target will be within ± 0.5 mm.

This specification is commonly used among sensor manufacturers and can be a useful point of comparison; however, it is a static measurement that may not represent the sensor's performance in real world applications.

Repeatability specs are based on detecting a single-color target that does not move. The specification does not factor in variability of the target, including speckle (microscopic changes in target surface) or color/reflectivity transitions that can have a significant impact on sensor performance.

Minimum Object Separation (MOS) refers to the minimum distance a target must be from the background to be reliably detected by a sensor. A minimum object separation of 0.5 mm means that the sensor can detect an object that is at least 0.5 mm away from the background.

Minimum object separation is the most important and valuable specification for discrete applications. This is because MOS captures dynamic repeatability by measuring different points on the same object at the same distance. This gives you a better idea of how the sensor will perform in real world discrete applications with normal target variability.

Key Specifications for IO-Link Applications

Repeatability, or how reliably the sensor can repeat the same measurement, is a common specification for IO-Link sensors. However, as with discrete applications, repeatability is not the only or most important factor for IO-Link applications.

Accuracy is the difference between the actual and measured values. It would be used in an application when you are looking at the measurement of an unknown distance, without a reference target. It is especially useful when comparing measurements from multiple sensors.

Linearity would be used instead of accuracy if looking at relative changes in measurements from a known reference target. This is similar to teaching the 4 mA and 20 mA points for an analog sensor, where all distance measurements are relative to the taught conditions.

Tip: Use the IQL Filter parameter available with Banner IO-Link sensors to average together more measurements for a more repeatable measurement



LM Series

Compact Precision Laser Measurement Sensor

- Highest short-range precision, even on shiny metals, for detection and error proofing
- Smallest spot size for more measurements and less color transition error
- Highest excess gain for detecting the darkest targets
- Lowest temperature effect for measurement stability in any environment
- Small stainless-steel housing for longevity and durability
- Dual Mode for contrast and clear object detection without a reflector

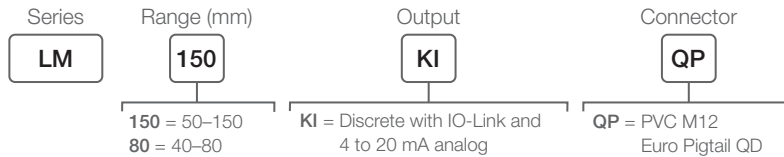

Precision Measurement Regardless of Target or Environment

Linearity

Linearity is the maximum deviation between an ideal straight line measurement and the actual measurement. The more linear a sensor is the more consistent and precise the sensing results. NOTE: Results shown in charts are based on LM150. Better performance will be achieved with the LM80.

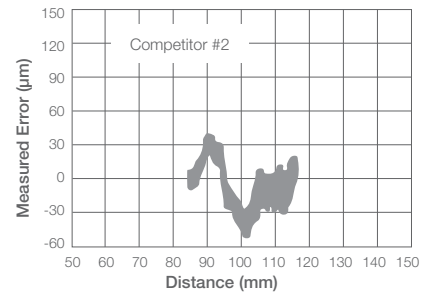
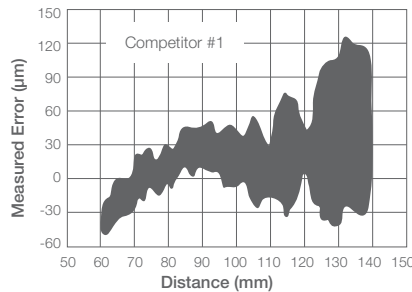
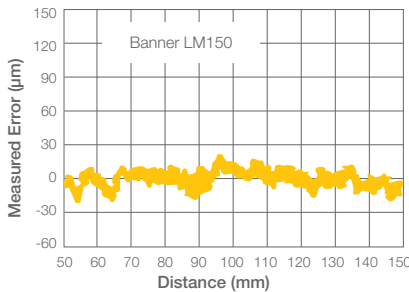

Example linearity on 90% white card

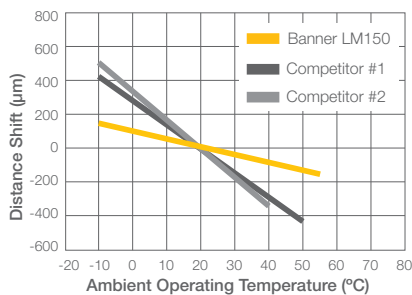

Example temperature effect at max range

Temperature Effect

A sensor with minimal temperature effect is critical for precise sensing applications since the induced error from just a few degrees of temperature shift can greatly impact sensors results.

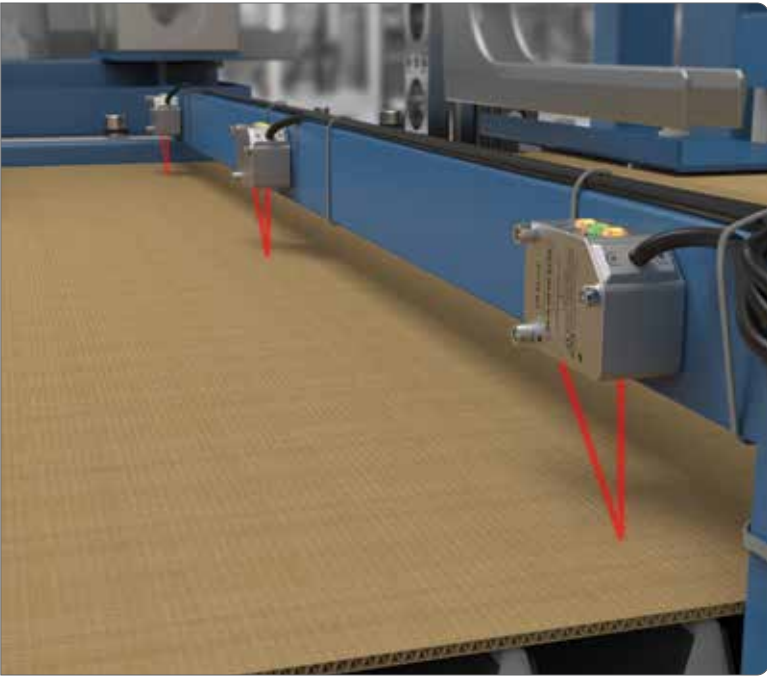

Material Thickness

Many times, product quality is verified at the end of the line. Material that is too thin or too thick must be scrapped. When running long rolls of product, it is preferable to continuously monitor the cardboard sheeting thickness, preventing large quantities of product from being out of specification and reducing scrapped material.

Challenge

Cardboard material is run in wide sheets and the thickness can vary from side to side and as well as along the entire length. The temperature in the plant can fluctuate several degrees throughout the day, introducing measurement error in most sensors.

Key Features

Three LM150s placed across the span of material monitor real-time changes in material thickness. The 0.004 mm resolution can detect very small changes in thickness. The extremely linear output of the LM150 is imperative when measuring long rolls of product. The LM150's stainless steel design makes it more stable across temperature changes in this environment.

Key Benefits

The thermal stability and precision of the LM150 help detect very small measurement changes in real time and signal the PLC to speed up or slow down the process, reducing waste.



Crankshaft Runout Measurement

Crankshaft runout is measured to make sure it is within the manufacturer's tolerance. If the crankshaft is out of tolerance, it can lead to mechanical failures and damage to the engine.

Challenge

A crankshaft can be a challenging target for any optical sensor, because the shiny metal generates specular reflections while oil residue can present a much darker target. In production environments, crankshafts are often rotated quickly to minimize the time spent on inspection and increase throughput.

Key Features

The LM has been designed with dynamic power adjustment for precision measurement across shiny and dark targets, providing less measurement variation and a more reliable inspection. The LM is capable of a 4kHz measurement rate, a best in class measuring speed, for more precise tracking of geometry changes and more robust inspections.

Key Benefits

The accuracy of the LM sensor can assure parts meet tight tolerances with fewer missed defects and false failures. High measurement speeds allow the LM to better identify a problem on fast moving parts while reducing time required for inspections.



Q4X Series

Versatile, Rugged, Laser Measurement Sensor

- Best price with performance short-range sensing solution
- Most compact, rugged IP69, Ecolab-certified, stainless steel housing
- Dual Mode for contrast and clear object detection without a reflector
- Flush mount or barrel mount housing options for versatility in mounting

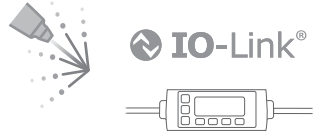

Threaded-Barrel Q4XT

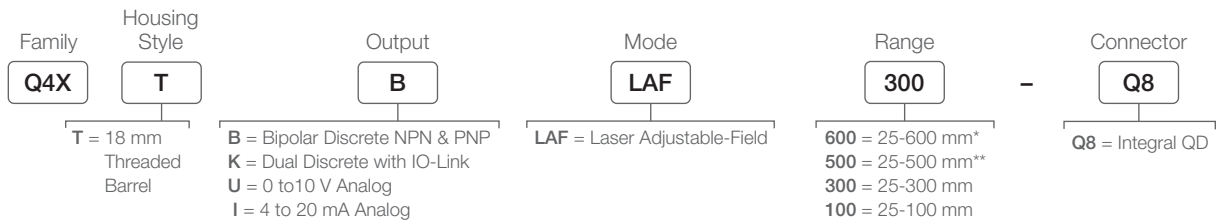

Flush-Mount Q4XF

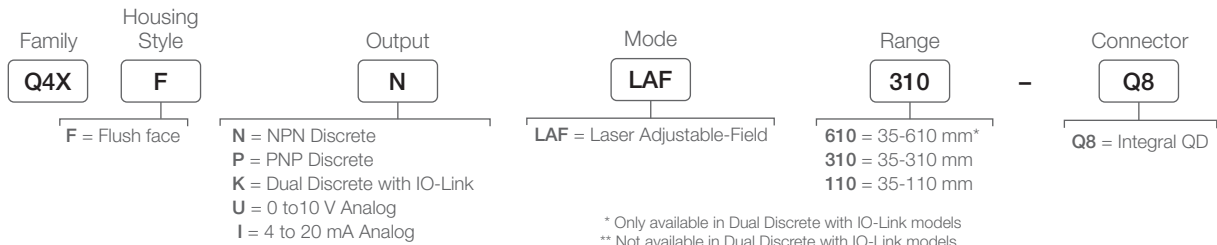

Distance: Precision Measurement and Detection Regardless of Target

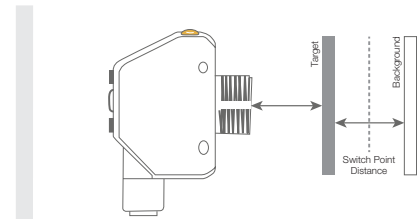
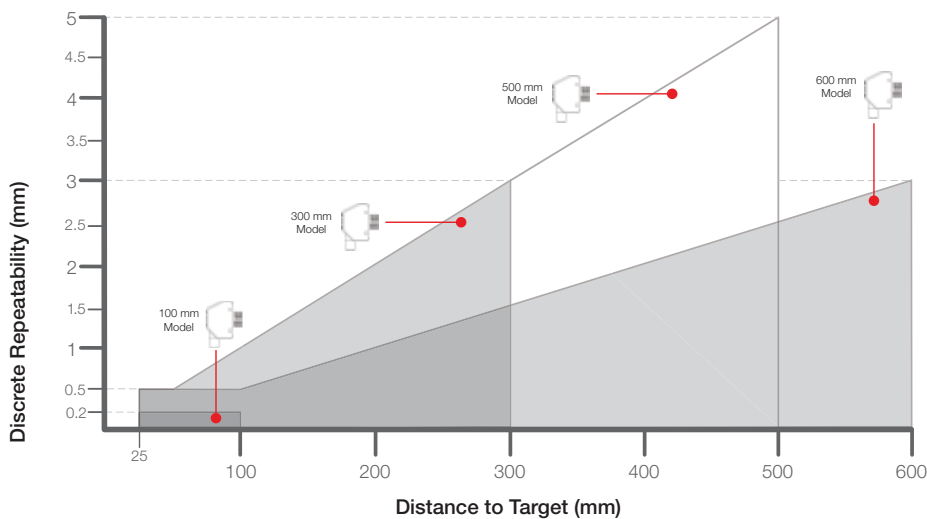

Minimum object detection size for challenging targets (6% reflectivity) at close range.

Q4X...100 / 110	0.5 mm
Q4X...300 / 310	1 mm
Q4X...500	1 mm
Q4X...600 / 610	1 mm

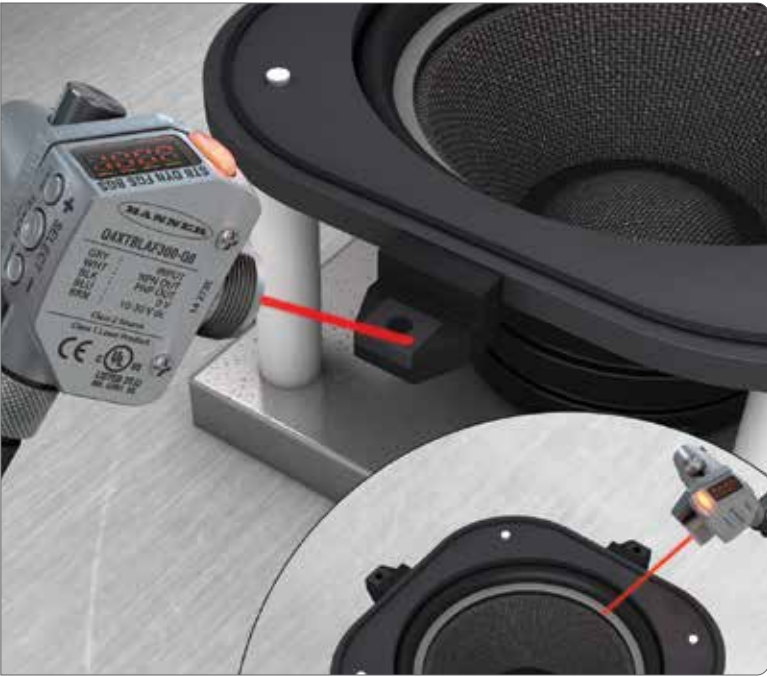

Error Proofing

Challenge

In a car speaker assembly, the presence and placement of all components must be verified to ensure that defective or incomplete product is not shipped to the customer. The small sizes, slim profiles and similar colors of many components can make identifying errors difficult.

Solution

By measuring the distance from the face of the sensor to the mounting bracket, a Q4X verifies that a single spacer is present and properly seated. Using dual mode detection, the Q4X can also measure the amount of light received to determine if the spacer has been placed with the adhesive side up or down. The compact size of the Q4X allows for an unobtrusive installation into congested assembly stations.



Clear Object Detection

Challenge

Regulating the flow of bottles on a conveyor can prevent damage to the bottles, product loss, machine downtime, and helps to ensure that downstream processes progress smoothly. Variations in bottle shape, size, material, color, and transparency can make detecting bottles and accumulations difficult.

Solution

Taught to recognize a stable background condition, a Q4X operating in dual mode will detect any alteration in the distance to and light intensity from the background condition, making the sensor immune to variations in bottle shape, size, color, clarity, and reflectivity. The Q4X has integral on/off delays that can send a signal if an accumulation occurs.



Q5X

High Power, Mid-Range Laser Measurement Sensor

- Best price with performance mid-range sensing solution
- Highest excess gain for detecting the darkest targets at extreme angles
- 100G shock spec for rugged applications
- Dual Mode for contrast and clear object detection without a reflector

excess gain IO-Link®

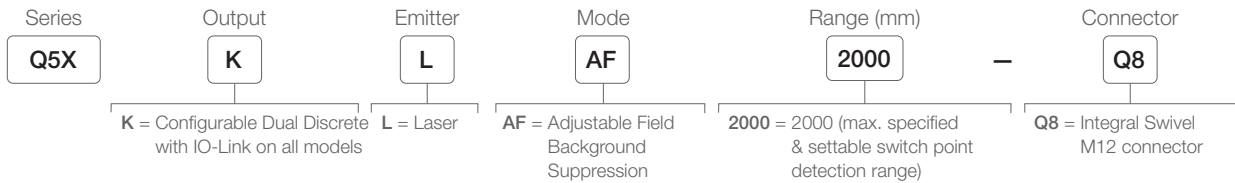

Best-in-Class Combination of Accuracy, Repeatability, and Range

Minimum Object Separation (MOS)

The minimum distance a target must be from the background to be reliably detected by a sensor. A MOS of 5 mm means the sensor can detect an object that is at least 5 mm from the background.

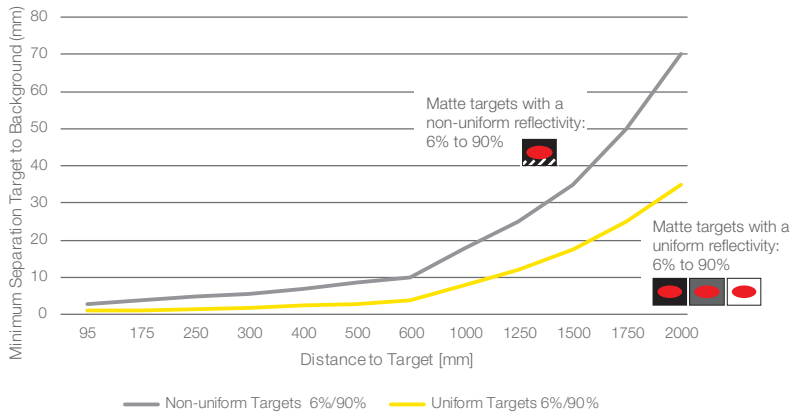
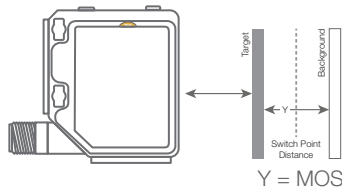

Excess Gain

Excess gain is a measure of the minimum light energy needed for reliable sensor operation. Higher excess gain allows the sensor to detect darker objects at steeper angles. Excess gain can be expressed as the following.

$$\text{Excess gain} = \frac{\text{Light energy falling on receiver element}}{\text{sensor's amplifier threshold}}$$

The threshold is the level of sensing energy required by the sensor's amplifier to cause the sensor's output to switch "ON" or "OFF."

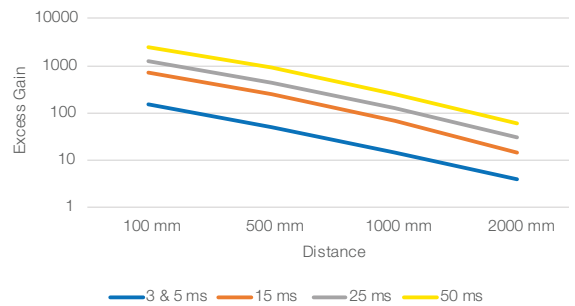



Automotive Seat Inspection

Challenge

In automotive quality inspections, verifying the presence of dark parts against an equally dark background is extremely common. For example, many car seats consist of black fabric or leather material with black plastic components, such as levers and buttons to adjust seat height and tilt.

Solution

Banner's Q5X problem-solving triangulation-based laser sensor has no difficulty detecting dark targets on dark backgrounds when there is a height difference. The exceptionally high excess gain enables the Q5X sensor to reliably detect even the darkest objects (<6% reflective black targets) even against a dark target at all distances from 9.5 cm to 2 m.



Dog Food Pallet Detection

Challenge

In packaging lines, the final step is the stretch wrapper. Bags of dog food are stacked on pallets, each pallet needs to be stretch-wrapped to help protect the finished goods during transport. Varying pallet heights require a sensing solution to determine the position of the top of the pallet in order to ensure that each pallet is fully wrapped.

Solution

The Q5X laser distance sensor is mounted to the top of the stretch wrapper to verify the height of dog food bags on the pallet. When the sensor no longer detects product at the taught distance, the stretch wrapper is stopped since the pallet is fully wrapped. The Q5X sensor is unaffected by color transitions and can reliably detect all different varieties of dog food, regardless of package color or reflectivity.



LE Series

Precision Mid-Range Laser Measurement Sensor

- Highest precision sensor for mid-range applications from 100 mm to 1 m
- Low temperature effect for measurement stability in any environment
- Intuitive Display
- Class 1 and Class 2 laser options
- Small and large spot options



IO-Link®

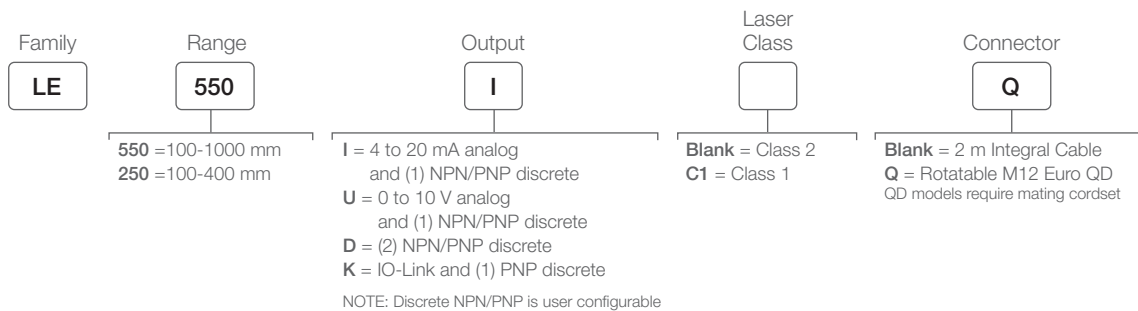

Precision Laser Measurement

LE250

- Measurement Range up to 400 millimeters
- Resolution as fine as 0.02 millimeters
- Small laser spot for detecting small features and best performance across changing colors and reflectivity



1.2 x 0.9 mm



12.1 mm x 4.9 mm

LE550

- Measurement Range up to 1 meter
- Sub millimeter resolution across entire range
- Larger spot for better measurement stability across uneven surfaces

400 mm

1000 mm

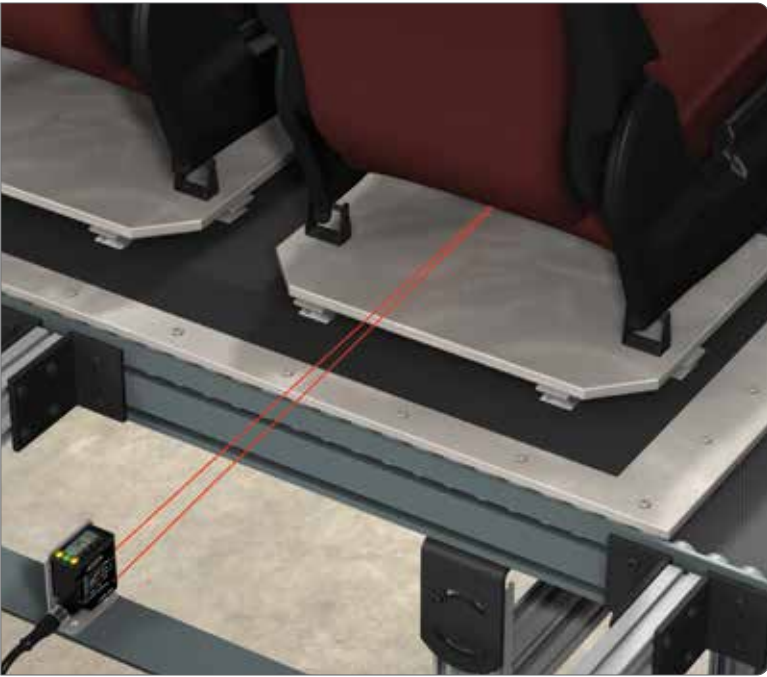

Automated Inspection

Challenge

To work properly, the weight sensor connector on the underside of the seat cushion must be fully inserted. If it is not, airbags will not deploy appropriately in an accident. These systems cannot be used by the vehicle manufacturer and will be returned. The difference between a fully inserted connector and one that is not is a distance of 4 mm. Implementing an automated inspection system would verify that weight sensor connectors were properly installed prior to being shipped.

Solution

Deployed alongside the assembly line, the L-GAGE LE550 targets the back of the weight sensor connector. The visible beam and small spot size make it easy to align and the LCD display greatly simplifies setup. To ensure unimpeded travel on the conveyor, the LE550 is located 500 mm from the target. From this range, it is capable of recognizing changes in distance as slight as 0.5 mm.

As the seat passes by, the L-GAGE LE550 measures the distance between it and the back of the connector. If the connector is measured at a distance less than 500 mm, an alarm notifies the operator and the line is briefly stopped. The operator can then correct the problem while it is easy to access the connector.



Roll Diameter

Challenge

Accurately determining the diameter of a roll of shrink wrap is essential to prevent material from running out during the shrink-wrapping process and ensure proper tensioning. As pallets enter the shrink-wrapping station, a reliable solution must provide accurate data to ensure the shrink wrap tension is what it should be and to alert operators if the roll of plastic wrap is empty.

Solution

Banner's LE550 is factory configured with a range of 100 to 1000 mm and can start measuring immediately. If the range needs to be adjusted, the laser sensor has an intuitive user interface with a two-line, eight-character display, making it easy to automatically or manually adjust settings. The LE550 provides repeatability and accuracy across challenging targets, from metal to black rubber, which allows for reliable measurement of the shrink wrap.

The analog output can be used to control wind or unwind speeds on the shrink wrap roll. The two point teach option can be used to teach the outside of the roll as the 20 mA point and can easily be adjusted for a manual set of the 4 mA point to the core diameter. This allows easy adjustment without having to unwind the entire roll. The discrete output can also be utilized for a roll diameter application. It can alert operators that the roll is almost empty.

The setup is simple using a single switch point. Similar to the manual adjust on the analog output, the user would adjust the feature to set a limit near the diameter of an empty core. No unwinding is needed to complete the discrete output setup.



LTF Series

Long-Range Laser Measurement Sensor

- Highest precision for long range sensing – beyond 1 meter
- Highest Ambient light immunity
- TOF vs. Triangulation
- 100G shock spec for rugged applications
- Intuitive Display

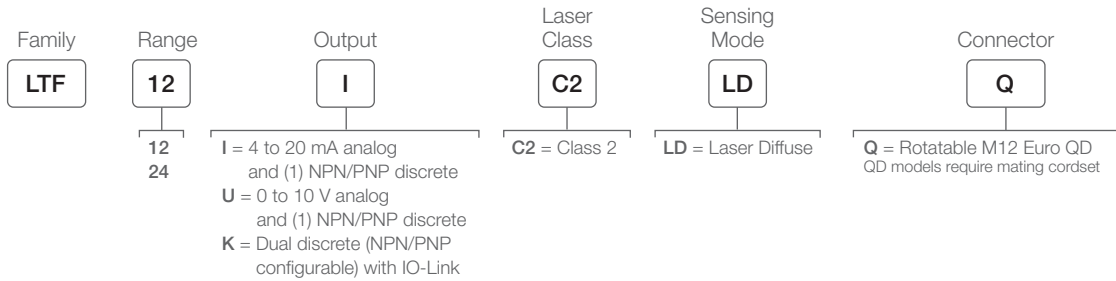

Best-in-Class Combination of Accuracy, Repeatability, and Range

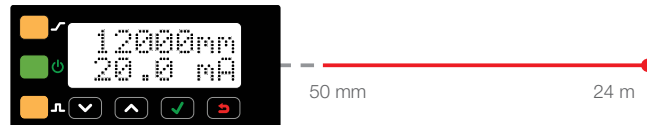
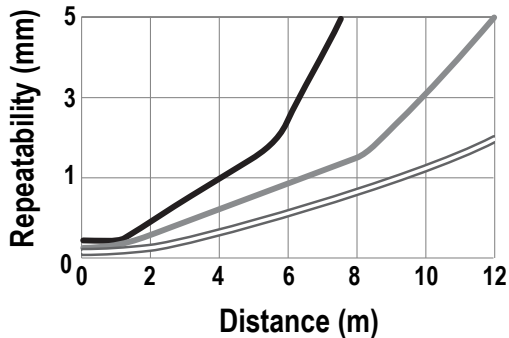

The LTF detects dark targets at 7 meters and white targets at 12 meters with repeatability <5 millimeters and accuracy from ±10 millimeters

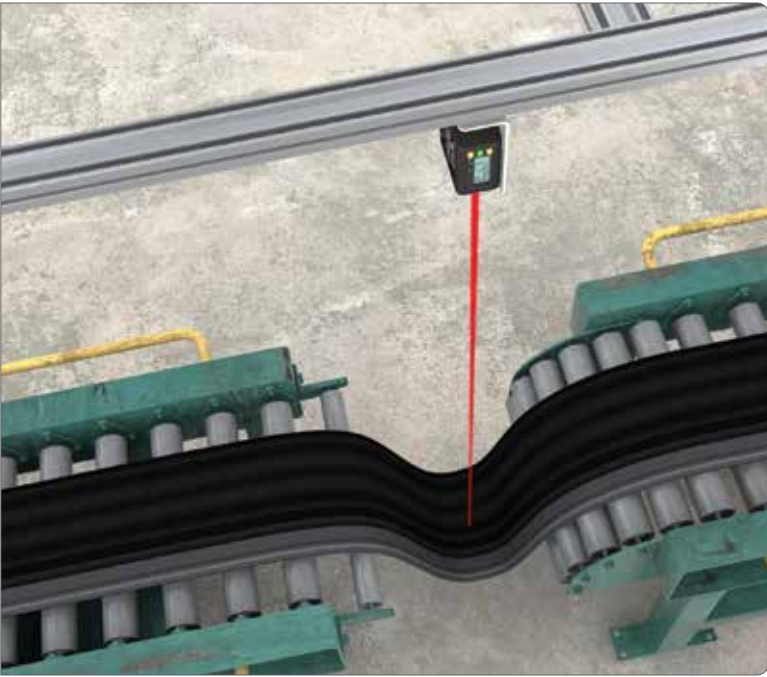

Loop Control on a Calendering Machine

Challenge

Measurement of loops of material are used to adjust machine speed and avoid excessive or insufficient tension that can damage the material. The dark color and sheen of the rubber makes consistent and accurate detection at a long range difficult for most sensors.

Solution

The LTF takes advantage of high excess gain, superior signal processing and automatic adaptive laser power control to enable the sensor to reliably detect challenging dark and reflective targets from a distance and at an angle.



Monitoring Levels Inside a High-Volume Hopper

Challenge

Dust and other debris generated during the processing of peanuts can accumulate on the face of a sensor. Gradually this can negatively affect a sensor's performance and may result in unscheduled downtime for maintenance.

Solution

An LTF Series sensor with IO-Link communicates configuration and application trending data via an IO-Link master device to a controller on an industrial network. Monitoring data such as excess gain can help identify debris build-up and assists in preventative maintenance and maximizing machine uptime. If the sensor is ever damaged and requires replacement, configuration data saved on the IO-Link master will automatically update the new sensor.

RSD

Remote Sensor Display

The RSD remote display is designed to provide easy sensor configuration and monitoring. It can be used for initial setup by equipment manufacturers with the ability to copy settings across many sensors.

- Allows for configuration of remote sensor heads
- Easy to set up and use with a 2-line, 8-character display
- Displays live distance measurement for remote monitoring
- Able to save up to 6 unique configurations
- Not required for continuous operation of configured sensor(s)
- Compatible with the LM, Q4X600, Q5X and LTF sensors

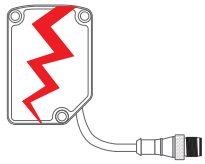

Simple device replacement with saved configurations

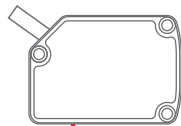
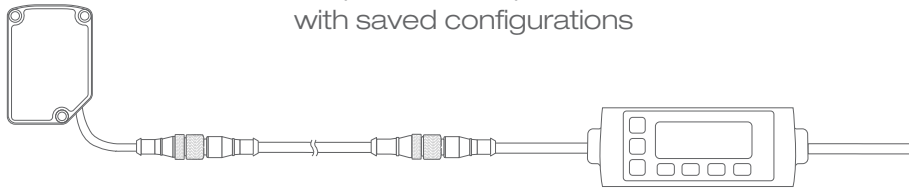

Ability to save up to 6 unique configurations for faster product changeover

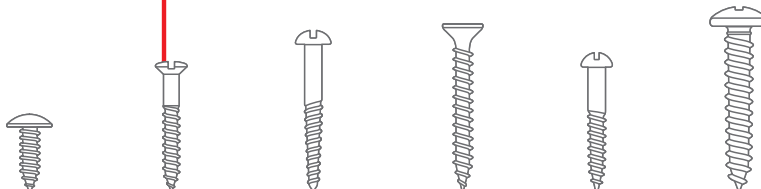

Additional laser sensors, cordsets, brackets, and other accessories available



Q60 Series 2 m Range Adjustable-Field Sensor

- Cost-effective sensing
- Offers infrared, visible red LED, or laser sensing beam
- Available with standard 10 to 30V dc and bipolar NPN/ PNP outputs or 12 to 250V ac and 24 to 250V ac with e/m relay output



LT3 Series 50 m Range Time-of-Flight Laser Sensor

- Retroreflective models with a 50 m range
- Offered in dual-discrete or analog/discrete models
- Includes push-button programming for three output response speeds
- Simplifies alignment with a bright, visible laser spot



LH High-Precision Laser Measurement Sensor

- Provides accurate and stable displacement or thickness measurement on wood, metal, rubber, ceramic, and plastic parts.
- Precise narrow laser spot for easy alignment to the target
- Target displacement or target thickness measurement with high resolution 4-20 mA or RS-485 serial communication outputs
- Two sensors self-synchronize for thickness measurements and thickness calculation within the sensors—no external controller required

Архангельск (8182)63-90-72
Астана (7172)727-132
Астрахань (8512)99-46-04
Барнаул (3852)73-04-60
Белгород (4722)40-23-64
Брянск (4832)59-03-52
Владивосток (423)249-28-31
Волгоград (844)278-03-48
Вологда (8172)26-41-59
Воронеж (473)204-51-73
Екатеринбург (343)384-55-89
Иваново (4932)77-34-06

Ижевск (3412)26-03-58
Иркутск (395)279-98-46
Казань (843)206-01-48
Калининград (4012)72-03-81
Калуга (4842)92-23-67
Кемерово (3842)65-04-62
Киров (8332)68-02-04
Краснодар (861)203-40-90
Красноярск (391)204-63-61
Курск (4712)77-13-04
Липецк (4742)52-20-81
Киргизия (996)312-96-26-47

Магнитогорск (3519)55-03-13
Москва (495)268-04-70
Мурманск (8152)59-64-93
Набережные Челны (8552)20-53-41
Нижний Новгород (831)429-08-12
Новокузнецк (3843)20-46-81
Новосибирск (383)227-86-73
Омск (3812)21-46-40
Орел (4862)44-53-42
Оренбург (3532)37-68-04
Пенза (8412)22-31-16
Казахстан (772)734-952-31

Пермь (342)205-81-47
Ростов-на-Дону (863)308-18-15
Рязань (4912)46-61-64
Самара (846)206-03-16
Санкт-Петербург (812)309-46-40
Саратов (845)249-38-78
Севастополь (8692)22-31-93
Симферополь (3652)67-13-56
Смоленск (4812)29-41-54
Сочи (862)225-72-31
Ставрополь (8652)20-65-13
Таджикистан (992)427-82-92-69

Сургут (3462)77-98-35
Тверь (4822)63-31-35
Томск (3822)98-41-53
Тула (4872)74-02-29
Тюмень (3452)66-21-18
Ульяновск (8422)24-23-59
Уфа (347)229-48-12
Хабаровск (4212)92-98-04
Челябинск (351)202-03-61
Череповец (8202)49-02-64
Ярославль (4852)69-52-93

<https://banner.nt-rt.ru/> || brr@nt-rt.ru